

Operation and Service Manual

Analog Multiplier

SIM985



Stanford Research Systems

Revision 1.00 • April 20, 2023

Certification

Stanford Research Systems certifies that this product met its published specifications at the time of shipment.

Warranty

This Stanford Research Systems product is warranted against defects in materials and workmanship for a period of one (1) year from the date of shipment.

Service

For warranty service or repair, this product must be returned to a Stanford Research Systems authorized service facility. Contact Stanford Research Systems or an authorized representative before returning this product for repair.

Information in this document is subject to change without notice.

Copyright © Stanford Research Systems, Inc., 2023. All rights reserved.

Stanford Research Systems, Inc.
1290–D Reamwood Avenue
Sunnyvale, CA 94089 USA
Phone: (408) 744-9040 • Fax: (408) 744-9049
www.thinkSRS.com • e-mail: info@thinkSRS.com

Contents

General Information	1
Safety and Preparation for Use	2
Service	2
Specifications	3
1 Operation	5
1.1 Introduction	6
1.1.1 Inputs	7
1.1.2 Outputs	7
1.1.3 Bandwidth	7
1.2 Distortion	8
1.3 DC accuracy	9
1.4 SIM Interface	10
1.4.1 SIM interface connector	10
1.4.2 Direct interfacing	11
2 Trimming	13
2.1 Overview	14
2.2 Offset trims	14
2.2.1 Equipment needed	14
2.2.2 Testing the offset voltages	15
2.2.3 Trimming the X and Y input offsets	15
2.2.4 Trimming the Output Offset	18
2.3 Bandwidth adjustment	18
2.4 Gain trim	20
2.4.1 Equipment needed	20
2.4.2 Procedure	21
3 Circuit Description	23
3.1 Block Diagram	24
3.2 Detailed description	24
3.2.1 Input stage	24
3.2.2 Multiplier	25
3.2.3 Output stage	25
3.2.4 Overload detection	25
3.2.5 Power	25
3.3 Schematics	26

General Information

The SIM985 Analog Multiplier, part of Stanford Research Systems' Small Instrumentation Modules family, is a low noise four-quadrant analog multiplier for use in signal conditioning applications from DC to 5 MHz.

Safety and Preparation for Use	2
Service	2
Specifications	3

Safety and Preparation for Use

The front-panel inputs and output, and the rear-panel output coaxial (BNC) connectors on the SIM985 are referenced to ground, and their outer cases are grounded. No dangerous voltages are generated by the module.



CAUTION

Do not exceed ± 15 V relative to Earth at the center terminal of any BNC connector.

The SIM985 is a single-wide module designed to be used inside the SIM900 Mainframe. Do not turn on the power until the module is completely inserted into the mainframe and locked in place.

Service

The only user-serviceable part inside the chassis is jumper J6, for selection of the output bandwidth limit. The SIM985 Analog Multiplier otherwise does not have any user serviceable parts inside. Refer service to a qualified technician.

Do not install substitute parts or perform any unauthorized modifications to this instrument. Contact the factory for instructions on how to return the instrument for authorized service and adjustment.

Specifications

All performance specifications after 1 hour warm-up at $(23 \pm 1)^\circ\text{C}$ ambient.

Input

Input range	$\pm 10\text{ V}$
Input impedance	$1\text{ M}\Omega$
Protection	$\pm 20\text{ Vdc}$
Offset	front panel trim

Multiplier

Transfer function	$V_{\text{Out}} = (V_X \times V_Y) / 10\text{ V}$
Slew rate, inputs and output	$120\text{ V}/\mu\text{s}$ (typ)
DC Accuracy ($-10\text{ V} \leq V_X, V_Y \leq +10\text{ V}$)	$< \pm(5\text{ mV} + 0.1\% \times V_{\text{Out}})$
Total harmonic distortion ($X=+10\text{ Vdc}$, $Y=7\text{ Vrms}$, $f < 5\text{ kHz}$)	$< -70\text{ dBc}$
Bandwidth (-3 dB) Jumper selectable	dc to 5 MHz (typ) 500 kHz , 50 kHz , 5 kHz , or 500 Hz

Output

Source impedance	$50\ \Omega$
Noise (referenced to output)	$1\ \mu\text{V}/\sqrt{\text{Hz}}$ (at 1 kHz , typ)
Offset	front panel trim

General

Connectors	
Inputs	2, X and Y (BNC)
Outputs	2, front and rear panels (BNC)
Power	DB-15 (male) SIM interface
Operating temp.	0°C to 40°C , non-condensing
Power	$\pm 15\text{ V}$ (150 mA , 350 mA short-circuit)
Weight	1.5 lb
Dimensions	$1.5 \times 3.6 \times 7.0$, inches

1 Operation

Description of the operation of the SIM985.

1.1 Introduction	6
1.1.1 Inputs	7
1.1.2 Outputs	7
1.1.3 Bandwidth	7
1.2 Distortion	8
1.3 DC accuracy	9
1.4 SIM Interface	10
1.4.1 SIM interface connector	10
1.4.2 Direct interfacing	11

1.1 Introduction

The SIM985 is a precision four-quadrant analog multiplier that can be used as a voltage-controlled gain element, a base-band mixer, or for general signal processing purposes.



Figure 1.1: The SIM985 front and rear panels.

The transfer function of the instrument is

$$V_{\text{Out}} = \frac{V_X \times V_Y}{10 \text{ V}}$$

where V_X and V_Y are the voltages applied to the X and Y input connectors, and V_{Out} is the output voltage available on either the front- or rear-panel output connectors.

For example, if $V_X = +8 \text{ V}$ and $V_Y = -7 \text{ V}$, the output will be

$$V_{\text{Out}} = \frac{(+8 \text{ V}) \times (-7 \text{ V})}{10 \text{ V}} = \frac{-56 \text{ V}^2}{10 \text{ V}} = -5.6 \text{ V}$$

The nominal range for all signals V_X , V_Y , and V_{Out} is $\pm 10 \text{ V}$. As the product is scaled by 10 V, the SIM985 does not amplify either input signal.

1.1.1 Inputs

The two inputs, X and Y, each have $1\text{ M}\Omega$ input impedance, and are DC-coupled. The inputs are generally symmetric, although the Y input has somewhat lower distortion for AC signals (see Section 1.2). Offset voltage trim is available through the front-panel trim holes, but should be performed following the procedure described in Section 2.2. If either input exceeds $\pm 10\text{ V}$, the **OVLD** indicator will light.

1.1.2 Outputs

The two output connectors, on the front and rear panels, are each driven separately through $50\ \Omega$ resistors. Under normal operation, both connectors may be used driving high impedances (greater than about $600\ \Omega$), or a single connector may be used to drive a $50\ \Omega$ load.

The output offset voltage can be trimmed through the front-panel trim hole, but this should be performed using the procedure described in Section 2.2.

1.1.3 Bandwidth

The bandwidth of the SIM985 is 5 MHz , but can be reduced using jumper J6, as described in Section 2.3. Additionally, the input and output signal circuitry are both limited to maximum slew rate of $120\text{ V}/\mu\text{s}$.

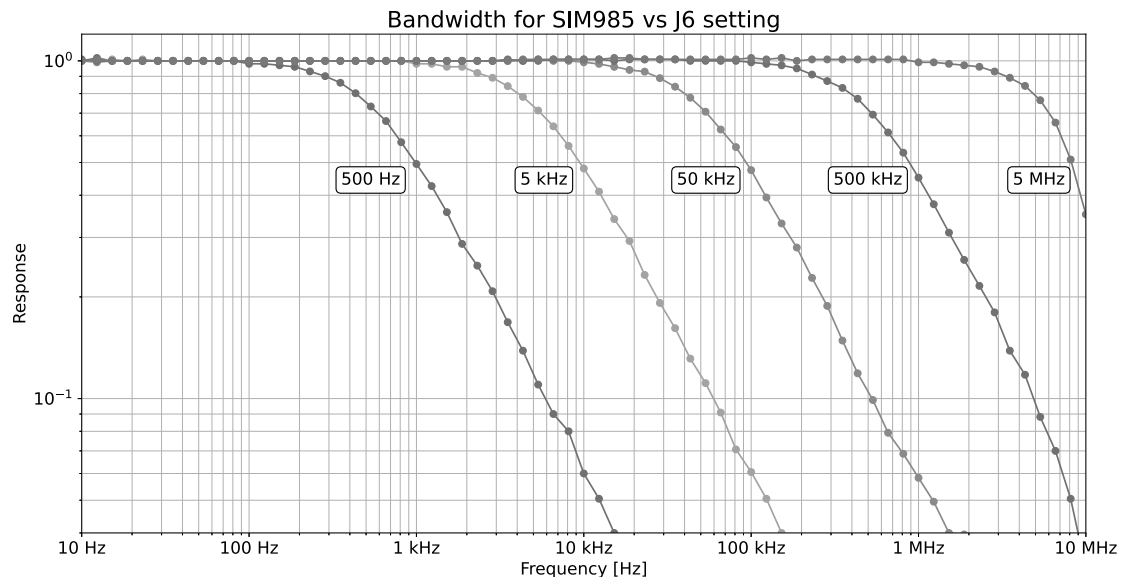

Figure 1.2: Typical bandwidth SIM985. The curves are labeled with the setting of jumper J6, which selects the bandwidth upper limit.

1.2 Distortion

Distortion is measured by applying +10 Vdc voltage to one input, and a 7 Vrms (± 10 V) sine-wave to the other input. Distortion is usually dominated by the 2nd harmonic below 10 kHz. At higher frequencies, odd harmonics can begin to dominate. Generally, the Y input will have somewhat lower distortion for large AC signals than the X input (see Figure 1.3).

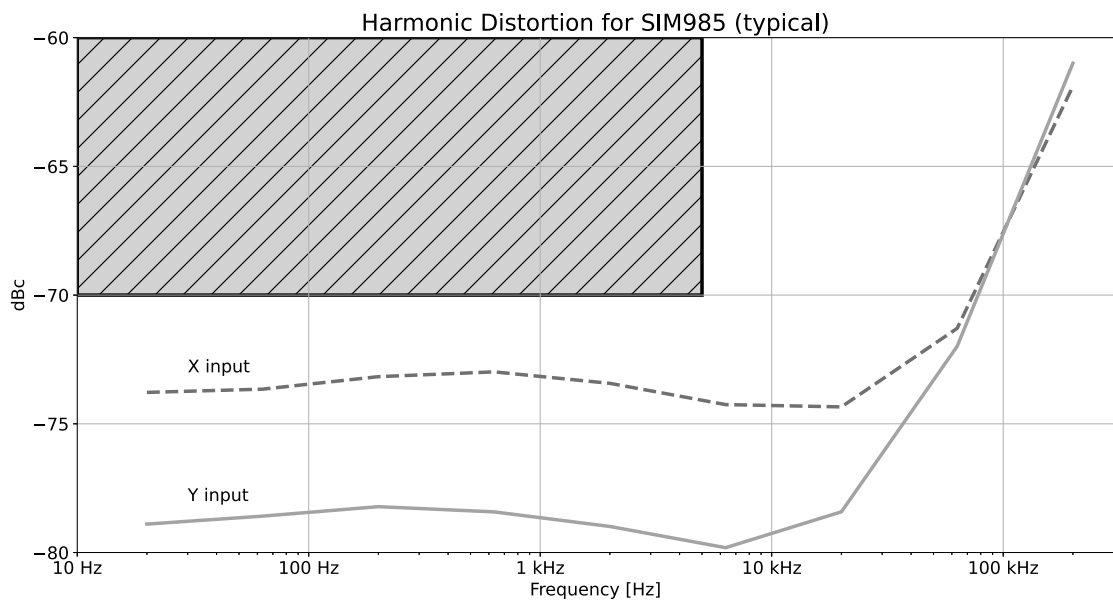

Figure 1.3: Typical harmonic distortion of the SIM985. The shaded region indicates the performance specification.

1.3 DC accuracy

DC accuracy is measured by driving the X and Y inputs from a pair of DC205 Precision DC Voltage Sources, recording the output voltage with a benchtop multimeter, and then subtracting the ideal output from the measurement: $V_{\text{Err}} = V_{\text{Meas}} - (V_X \times V_Y)/10\text{V}$. Figure 1.4 shows a contour plot of the typical errors for a SIM985.

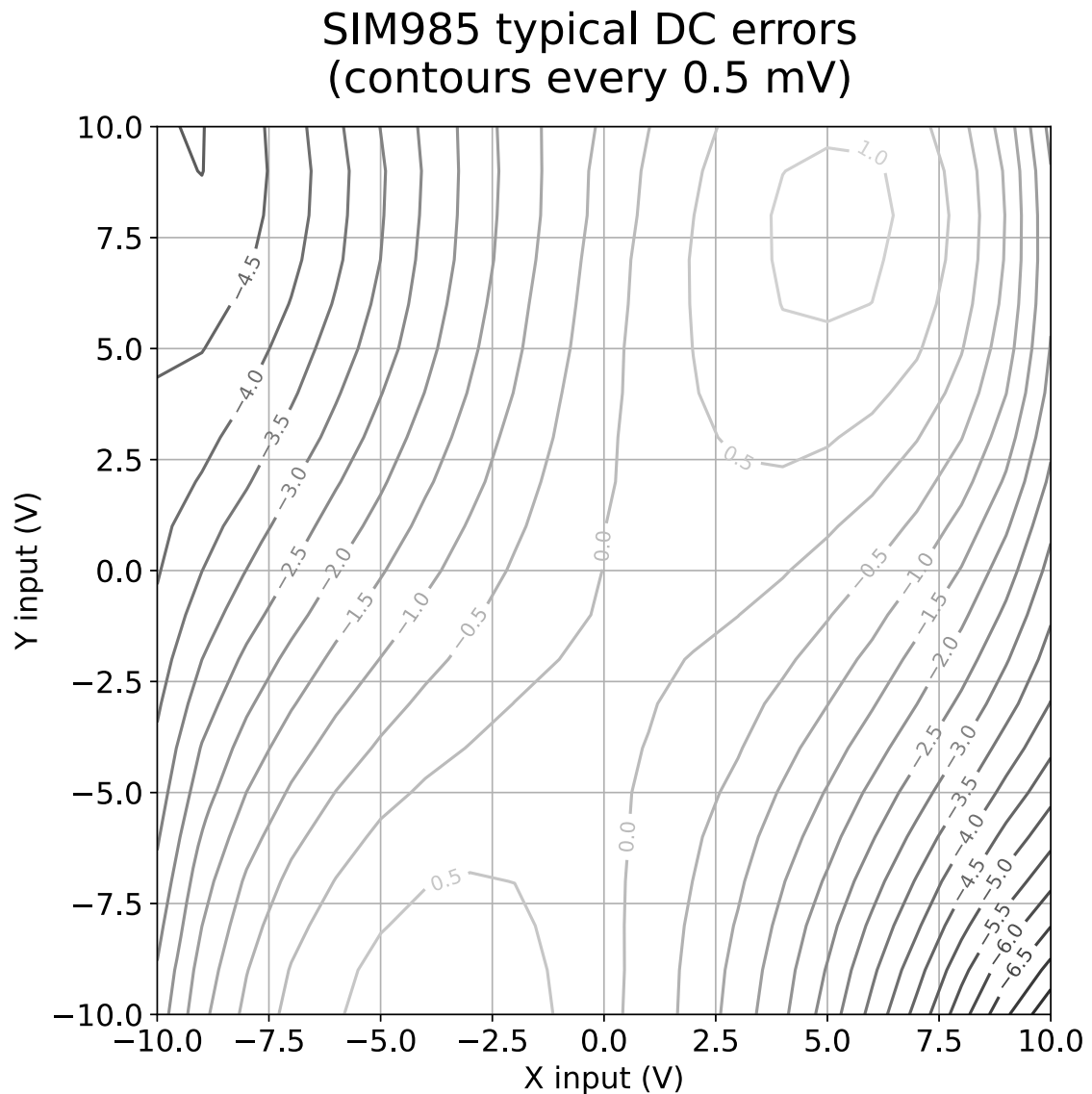

Figure 1.4: Typical DC errors for the SIM985.

1.4 SIM Interface

The primary connection to the SIM985 is the rear-panel DB-15 SIM interface connector. Typically, the SIM985 is mated to a SIM900 Mainframe via this connection, either through one of the internal Mainframe slots, or the remote cable interface.

It is also possible to operate the SIM985 directly, without using the SIM900 Mainframe. This section provides details on the interface.



CAUTION

The SIM985 has no internal protection against reverse polarity, missing supply, or overvoltage on the power supply pins. Misapplication of power may cause circuit damage. SRS recommends using the SIM985 together with the SIM900 Mainframe for most applications.

1.4.1 SIM interface connector

The DB-15 SIM interface connector carries the power and status lines to the instrument. The connector signals are specified in Table 1.1

Pin	Signal	Direction Src ⇒ Dest	Description
1	SIGNAL_GND	MF ⇒ SIM	Ground reference for signal
2	-STATUS	SIM ⇒ MF	Overload monitor (GND = overload, high-Z = idle)
3	RTS	MF ⇒ SIM	HW handshake (unused in SIM985)
4	CTS	SIM ⇒ MF	HW handshake (unused in SIM985)
5	-REF_10MHZ	MF ⇒ SIM	10 MHz reference (unused in SIM985)
6	-5 V	MF ⇒ SIM	Power supply (unused in SIM985)
7	-15 V	MF ⇒ SIM	Power supply
8	PS_RTN	MF ⇒ SIM	Power supply return
9	CHASSIS_GND		Chassis ground
10	TXD	MF ⇒ SIM	Async data (unused in SIM985)
11	RXD	SIM ⇒ MF	Async data (unused in SIM985)
12	+REF_10MHz	MF ⇒ SIM	10 MHz reference (unused in SIM985)
13	+5 V	MF ⇒ SIM	Power supply (unused in SIM985)
14	+15 V	MF ⇒ SIM	Power supply
15	+24 V	MF ⇒ SIM	Power supply (unused in SIM985)

Table 1.1: SIM Interface Connector Pin Assignments, DB-15

1.4.2 Direct interfacing

The SIM985 is intended for operation in the SIM900 Mainframe, but users may wish to directly interface the module to their own systems without the use of additional hardware.

The mating connector needed is a standard DB-15 receptacle, such as Amp part # 747909-2 (or equivalent). Clean, well-regulated supply voltages of ± 15 VDC must be provided, following the pin-out specified in Table 1.1. Ground must be provided on pins 1 and 8, with chassis ground on pin 9. The $-\text{STATUS}$ signal may be monitored on pin 2 for a low-going open-collector output indicating an overload, but the user must provide a pull-up resistor of at least $10\text{ k}\Omega$ to $+5\text{ V}$.

2 Trimming

Description of the trimming procedures for the SIM985.

2.1	Overview	14
2.2	Offset trims	14
2.2.1	Equipment needed	14
2.2.2	Testing the offset voltages	15
2.2.3	Trimming the X and Y input offsets	15
2.2.3.1	Oscilloscope method	16
2.2.3.2	Lock-in method	17
2.2.3.3	DC method	18
2.2.4	Trimming the Output Offset	18
2.3	Bandwidth adjustment	18
2.4	Gain trim	20
2.4.1	Equipment needed	20
2.4.2	Procedure	21

2.1 Overview

The SIM985 provides user adjustments to modify the input and output DC offset voltages, and also the AC small-signal bandwidth. One additional trim point, to adjust to overall gain, is documented here but is not intended as a user adjustment.

2.2 Offset trims

Three trim adjustments, available through the access holes on the front panel, allow users to adjust the input and output offset voltages. This trimming is performed at the factory when the SIM985 is manufactured and calibrated, and will normally not require user adjustment.

With its fundamentally non-linear transfer function, offset voltages in the SIM985 may contribute to gain errors or DC offset errors. Because of this ambiguity, the following procedures are recommended to first measure the offset voltages prior to adjusting them.

2.2.1 Equipment needed

- Function generator capable of ± 10 V square wave outputs, such as the DS345
- DC voltage source with at least ± 10 V output and sub-millivolt accuracy, such as the DC205
- Multimeter with at least 5 ½ digit resolution and sub-millivolt accuracy
- One of either:
 - Two-channel oscilloscope
 - Lock-in amplifier, such as the SR860
- Several coax cables with BNC connectors
- BNC-to-banana adapters necessary for connecting to the multimeter and the DC voltage source.
- a BNC tee-connector, and two BNC 50 Ω terminators
- Small flat blade adjustment screwdriver, able to fit into a 0.100 in (2.5 mm) diameter access hole.

2.2.2 Testing the offset voltages

The quick test can be performed using the DC voltage source and the multimeter. A total of 5 measurements are required.

Begin by powering up the SIM985 and ensuring it has warmed up for at least 1 hour.

- Connect the SIM985 OUTPUT to the multimeter, and leave both inputs open. Record the measured output voltage as "Output Offset".
- Connect the DC voltage source to the Y INPUT, and set the source to +10 V. Record the output voltage as "+ X Offset".
- Change the source to -10 V, and then record the output voltage as "- X Offset."
- Move the BNC cable connecting the source to the SIM985, so it is now connected to the X INPUT connector. Record the output as "- Y Offset".
- Change the source back to +10 V, and record the output voltage as "+ Y Offset.

If all 5 measurements are less than ± 3 mV, then no additional trim is necessary. Conversely, if any of the 5 measurements exceeds ± 5 mV, then the unit is out of specification and requires offset trimming.

If the Output Offset is less than ± 3 mV, but one or more of the Input Offsets is between ± 3 mV and ± 5 mV, the unit may or may not benefit from retrimming the offsets. Specifically, if both of the X Offsets are larger than 3 mV magnitude but of opposite polarity, or if both of the Y Offsets are larger than 3 mV magnitude but of opposite polarity, then the measured offsets will likely improve by retrimming.

2.2.3 Trimming the X and Y input offsets

Trimming the input offsets can be performed using either an oscilloscope or a lock-in amplifier. Both procedures are described here, but generally the lock-in method produces the best results. A third method, using only the DC source and multimeter, is also described but will typically take more iterations to converge.

2.2.3.1 Oscilloscope method

To configure the setup for trimming the input offsets with an oscilloscope:

- Set the function generator to 20 Hz, and generate a ± 10 V square wave output.
- Attach the BNC tee to the Channel 2 input of the oscilloscope, and then connect the output of the function generator to the tee. Connect the other end of the tee to the Y INPUT of the SIM985.
- Set the 'scope trigger to Channel 2, and verify the scope is triggering stably, and that the function is a square wave going between -10 V and $+10$ V.
- Connect the BNC $50\ \Omega$ terminator to the X INPUT of the SIM985.
- Connect the OUTPUT of the SIM985 to the Channel 1 input of the oscilloscope.

Adjust the oscilloscope vertical scale for Channel 1 to display any residual square wave. The signal is likely to be only a few mV; you may need to configure the 'scope acquisition mode to "average" to see the result.

Use the narrow screwdriver to slowly adjust the trim pot just to the left of the X INPUT connector. Adjust until the residual square wave on Channel 1 is as close to flat as possible.

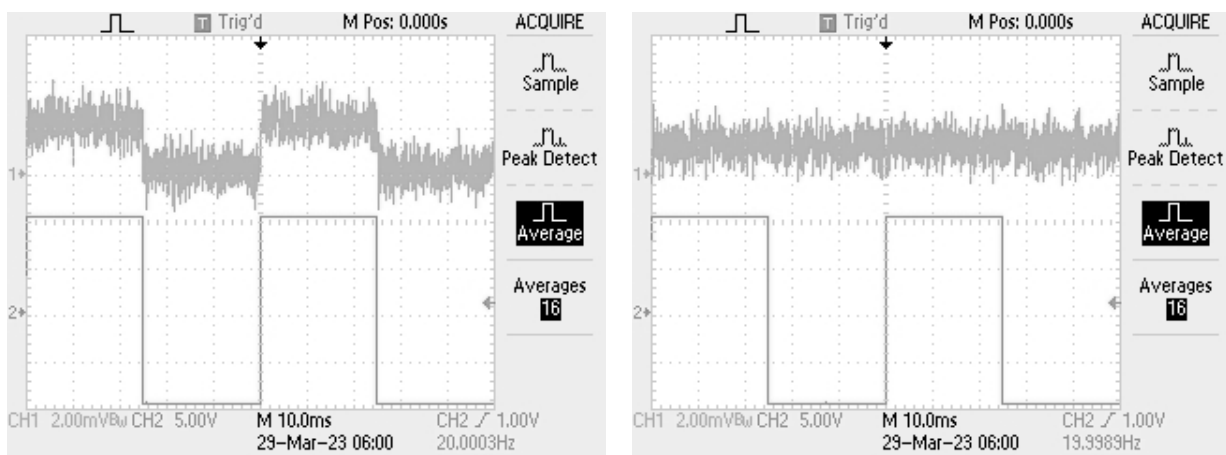

Figure 2.1: Trimming the SIM985 with the oscilloscope method. The image on the left shows a 1 mV residual X INPUT offset, while the image on the right is fully trimmed.

After trimming the X INPUT, swap the BNC $50\ \Omega$ terminator and the BNC cable connected to the Y INPUT, so the function generator is now

connected to the X INPUT. Repeat the same procedure as above, but adjust the trimmer adjacent to the Y INPUT.

2.2.3.2 Lock-in method

To configure the setup for trimming the input offsets using a lock-in amplifier:

- Set the function generator to 20 Hz, and generate a ± 10 V square wave output.
- If the function generator has a separate Sync output:
 - Connect the function generator Sync output to the lock-in amplifier External Reference Input terminal
 - Connect the function generator main output to SIM985 Y INPUT connector.
- Otherwise:
 - Connect a BNC tee to the lock-in amplifier External Reference Input connector.
 - Connect the function generator Output to the BNC tee, and then connect the Tee to the SIM985 Y INPUT.
- Set the lock-in reference source to External, and verify that it locks to 20 Hz.
- Connect the BNC 50 Ω terminator to the X INPUT of the SIM985.
- Connect the OUTPUT of the SIM985 to the signal input of the lock-in amplifier.
- Configure the lock-in to millivolt sensitivity, and set the time constant to 100 ms and at least 18 dB/oct. filter slope. Be sure the lock-in phase is set to zero.

The lock-in "X" signal (in-phase detection) is equal to $0.90 \times$ the SIM985 X INPUT offset. Use the narrow screwdriver to slowly adjust the trim pot just to the left of the X INPUT connector. Adjust until the lock-in "X" signal is as close to zero as possible. It should be easy to trim to less than $\pm 100 \mu\text{V}$.

After trimming the X INPUT, swap the BNC 50 Ω terminator and the BNC cable connected to the Y INPUT, so the function generator is now connected to the X INPUT. Repeat the same procedure as above, minimizing the lock-in "X" signal, but adjusting the trimmer adjacent to the Y INPUT.

2.2.3.3 DC method

To configure the setup for trimming the input offsets using a DC source:

- Set the DC source to +10 V output, and connect the output to the Y INPUT on the SIM985.
- Connect the BNC 50 Ω terminator to the X INPUT of the SIM985.
- Connect the OUTPUT of the SIM985 to the input of the multimeter, and set the meter to its millivolt range

To begin, use the narrow screwdriver to slowly adjust the trim pot to the left of the X INPUT connector. Adjust until the multimeter reads as close to zero as possible. It should be easy to trim to less than $\pm 100 \mu\text{V}$.

Next, set the DC source to -10 V output, and note the reading on the multimeter. If the reading is outside the range $\pm 500 \mu\text{V}$, then trim the X INPUT offset until the multimeter reads *half* of the noted value. For example, if the multimeter reads -4.8 mV when the DC source was switched to -10 V , then adjust until the meter reads -2.4 mV .

Set the DC source back to +10 V output. If the two readings (for +10 V and -10 V) are within $\pm 200 \mu\text{V}$, then stop. If not, continue to make small adjustments, alternating between +10 V and -10 V applied to the Y INPUT, until the multimeter readings are within $\pm 200 \mu\text{V}$ of each other.

After trimming the X INPUT, swap the BNC 50 Ω terminator and the BNC cable connected to the Y INPUT, so the DC source is now connected to the X INPUT. Repeat the same procedure as above, but adjusting the trimmer adjacent to the Y INPUT.

2.2.4 Trimming the Output Offset

Once both input offsets are trimmed, the output offset may now be trimmed. Connect a 50 Ohm terminator to X INPUT and the Y INPUT, and connect the OUTPUT to the multimeter.

Using the small screwdriver, adjust the trim pot just to the left of the OUTPUT connector to bring the multimeter reading as close to zero as possible. Typically, you should be able to trim the output offset to better than $100 \mu\text{V}$.

2.3 Bandwidth adjustment

As shipped from the factory, the SIM985 is configured for full bandwidth (5 MHz) operation. In some situations, users may wish to reduce the output bandwidth.

A user-servicable jumper is in the SIM985, allowing users to select output bandwidth from 500 Hz to 5 MHz, in decade steps. To change this jumper setting:

- Remove the SIM985 from the SIM900 mainframe, or if using a stand-alone power supply, remove power from the unit.
- Remove the four small black screws from the top and bottom of the unit that fasten the right-hand cover (as viewed from the front panel). Remove the side cover to expose the internal circuit board.
- Locate jumper block J6, labeled "Bandwidth Selector", near the bottom center of the board.
- Carefully lift the black jumper from its current installed location (5 MHz by default), and install it firmly in the position corresponding to the desired output bandwidth.

The jumper should be installed vertically, as shown in Figure 2.2.

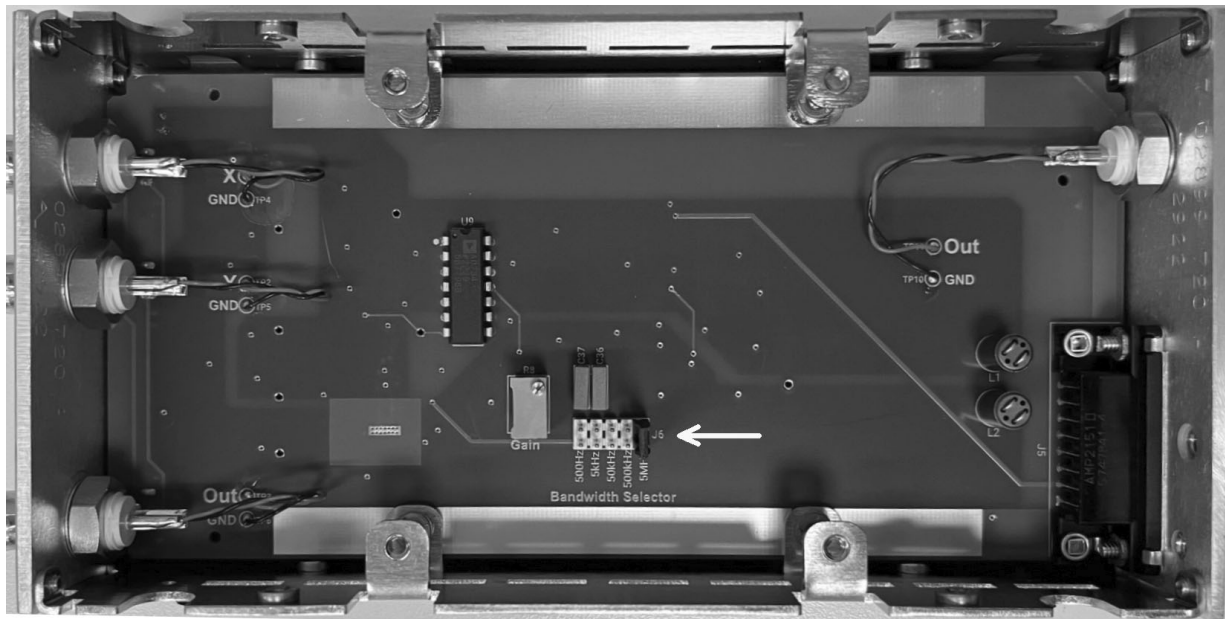

Figure 2.2: Bandwidth selector J6, shown configured for 5 MHz output bandwidth.

2.4 Gain trim

Typically, users should not attempt to adjust the SIM985 gain trim, as this is set at the factory and exhibits excellent long-term stability. However, in some limited circumstances (such as user replacement of U9), adjusting the gain may be helpful.

2.4.1 Equipment needed

- DC voltage source with at least ± 10 V output and sub-millivolt accuracy, such as the DC205
- Multimeter with at least 5 ½ digit resolution and sub-millivolt accuracy
- Several coax cables with BNC connectors
- BNC-to-banana adapters necessary for connecting to the multimeter and the DC voltage source.
- a BNC tee-connector
- Small flat blade adjustment screwdriver, able to fit into a 0.100 in (2.5 mm) diameter access hole.
- (optional) 15-pin remote power cable to power SIM985 outside of the SIM900 Mainframe

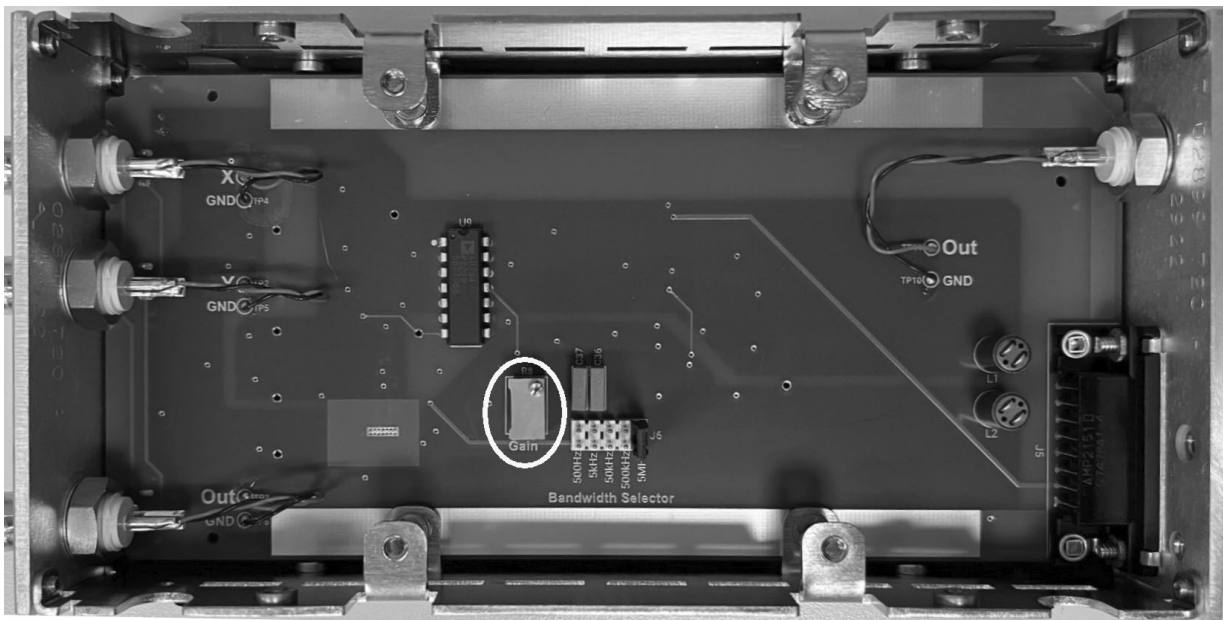

Figure 2.3: Gain trimmer, R8

To trim the gain, the SIM985 must be operated with the right-hand cover removed (as viewed from the front). This requires either operating the unit outside of the SIM900 mainframe on the optional remote power cable, or carefully installing the unit into Slot 1 of the SIM900, with the remaining slots empty, to permit access to the trim pot on the circuit board.

2.4.2 Procedure

- Remove the right hand cover, and locate R8 (the Gain trim pot). See Figure 2.3. Be sure you have access to adjust this trimmer as described above.
- Connect the BNC Tee to the X INPUT of the SIM985, and connect one side of the Tee to the Y INPUT.
- Set the DC Source output to 0.000 V
- Connect the other side of the Tee to the DC Source.
- Connect the SIM985 OUTPUT to the multimeter.
 - Verify the multimeter reads within $\pm 500 \mu\text{V}$ of zero.
 - If the offset is greater than this, perform the offset trim procedure described in Section 2.2 before proceeding.
- Set the DC source to +8.0000 V, and adjust the Gain trimmer until the multimeter reads +6.4000 V.
- Set the DC source to -8.0000 V, and verify the multimeter still reads +6.4000 V.
- Iterate between +8.0000 V and -8.0000 V, adjusting to keep the multimeter as close to +6.4000 V for both settings.

3 Circuit Description

Description of the circuitry used in the SIM985.

3.1	Block Diagram	24
3.2	Detailed description	24
3.2.1	Input stage	24
3.2.2	Multiplier	25
3.2.3	Output stage	25
3.2.4	Overload detection	25
3.2.5	Power	25
3.3	Schematics	26

3.1 Block Diagram

The SIM985 Analog Multiplier is built around the AD734 high speed four-quadrant multiplier chip, as shown in the simplified block diagram (Figure 3.1). Each of the inputs (X and Y) are separately buffered with JFET-input op-amps, while the output stage is buffered with a composite amplifier configured for inverting gain.

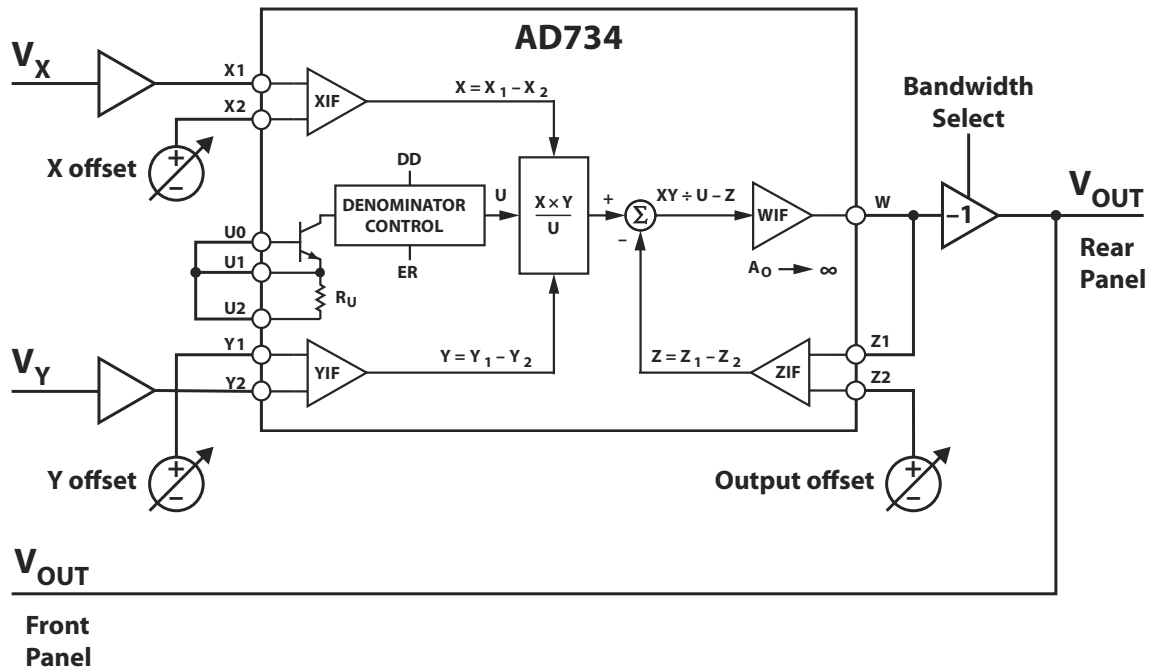

Figure 3.1: Simplified block diagram of the SIM985.

3.2 Detailed description

In the descriptions that follow, circuit designators are with reference to the schematics at the end of this document.

3.2.1 Input stage

The X (Y) input is buffered by U1 (U7), an OPA828 high speed JFET op-amp. Input impedance is set to 1 M Ω by R6 (R23), and a series resistor R4 (R20) provides input protection for the op-amp. Note the Y input is connected to the inverting input of the multiplier—this is to account for the inverting output amplifier, so the overall transfer function of the SIM985 is non-inverting.

The OPA828 input offset voltage is much smaller than that of the AD734, so input offset trimming is provided using the differential voltage inputs

of the multiplier. Trimmer R24 (R25) provides an offset voltage between -2.5 V and $+2.5\text{ V}$, which is then divided by 200 by R17, R18 (R21,R22).

3.2.2 Multiplier

U9, the AD734, provides the four-quadrant analog multiplication function. Output offset trimming is provided by R27, divided by R14,R15, and connected to the output summing amplifier of U9.

3.2.3 Output stage

The output stage is a composite amplifier comprised of U5, an OPA828 op-amp, and U3, a BUF634A power buffer. This amplifier is configured for inverting gain of -1 with R7 and R9. Gain trimmer R8 provides fine adjustment of the gain, and is used to trim out the scale error in the AD734 "denominator control" reference.

Capacitors C34, C35, C36, and C37 all provide bandwidth limiting for the output stage, and are selected by jumper J6. When the jumper is installed in the 9–10 position (5 MHz), no additional feedback capacitor is connected to the summing junction of the output amplifier.

The output impedance is separately defined for the front-panel and rear-panel outputs by R42,R43,R44,R45, and R37,R39,R40,R41, respectively.

3.2.4 Overload detection

Comparators U8A and U8B (TLV1702) compare time-stretched copies of the input and output voltages to -10 V and $+10\text{ V}$, using diodes D4, D5, D6, and RC networks C22,R32 and C24,R35. If an overload is detected, transistor Q1 conducts, illuminating the **OVLD** LED D1. This also energizes the open-collector output of Q2, which will assert the $-\text{STATUS}$ signal low for possible detection through the SIM900 mainframe and its SSCR register.

3.2.5 Power

Power for the SIM985 is provided on pins 7 and 14 of the 15-pin SIM connector, J5. For normal operation, this power is provided by the SIM900 Mainframe. See Section 1.4.2 for information on directly powering to the SIM985.

3.3 Schematics

Schematics follow this page.

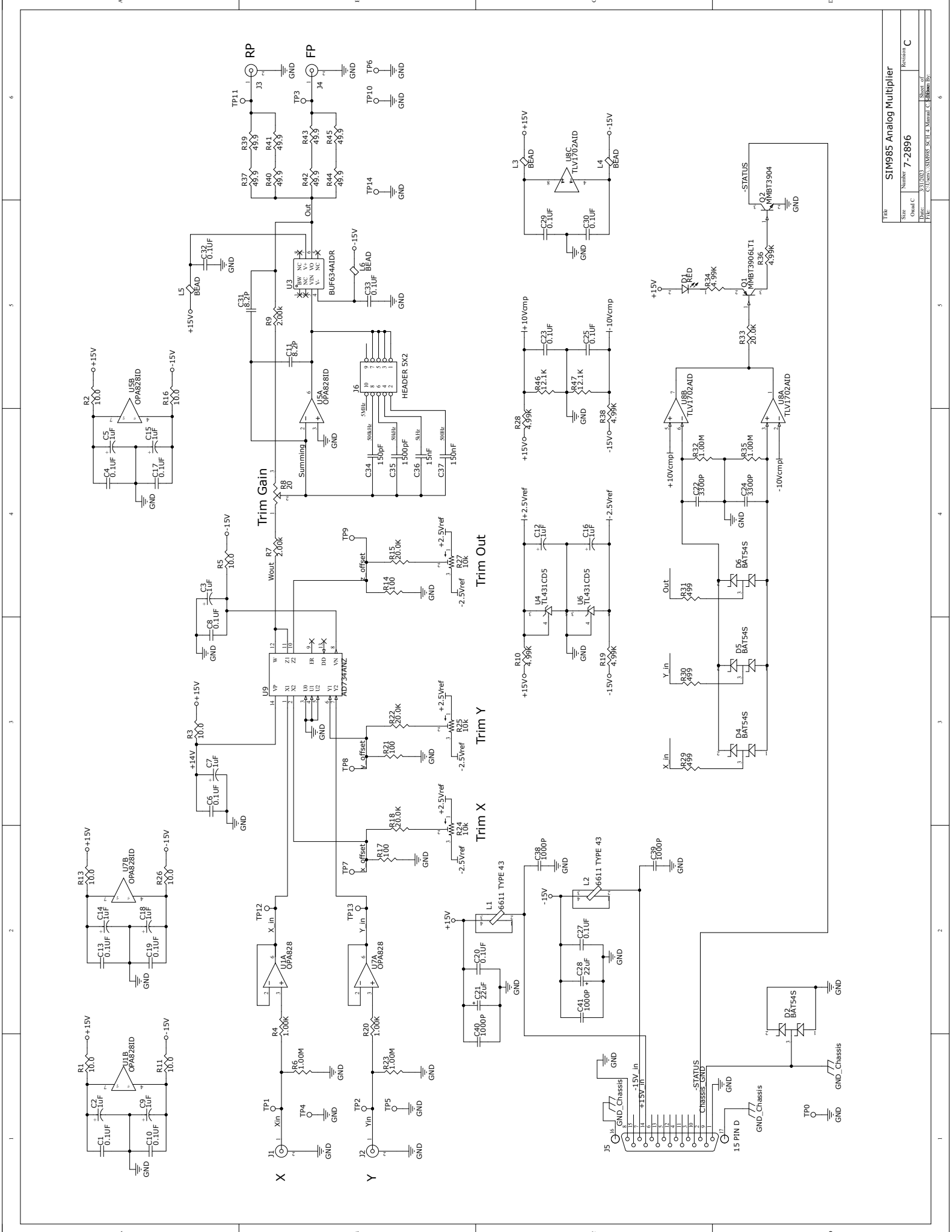

File	SIM985 Analog Multiplier		
Size	Number	Revision	
Owned C	7-2896	C	
Date	3/17/2023	Sheet of	3
Type	C:\Users\sim985\OneDrive\Desktop\BIP	Sheet of	3