

Operating Manual and Programming Reference

# Precision Optical Chopper

---

**SR542**



---

Revision 1.5 • June 23, 2023

## **Certification**

Stanford Research Systems certifies that this product met its published specifications at the time of shipment.

## **Warranty**

This Stanford Research Systems product is warranted against defects in materials and workmanship for a period of one (1) year from the date of shipment.

## **Service**

For warranty service or repair, this product must be returned to a Stanford Research Systems authorized service facility. Contact Stanford Research Systems or an authorized representative before returning this product for repair.

Information in this document is subject to change without notice.

Copyright © Stanford Research Systems, Inc., 2023. All rights reserved.

Stanford Research Systems, Inc.  
1290–D Reamwood Avenue  
Sunnyvale, CA 94089 USA  
Phone: (408) 744-9040 • Fax: (408) 744-9049  
**www.thinkSRS.com • e-mail: info@thinkSRS.com**

---

## Contents

---

<b>General Information</b>	<b>1</b>
Safety and Preparation for Use . . . . .	2
AC Line Voltage . . . . .	2
Line Cord . . . . .	2
Service . . . . .	2
Symbols on the SR542 . . . . .	3
Notation . . . . .	3
Specifications . . . . .	4
Blade Specifications . . . . .	5
Mechanical Dimensions . . . . .	7
Controller . . . . .	7
Chopper Head . . . . .	8
Chopper Blade . . . . .	9
<b>1 Getting Started</b>	<b>11</b>
1.1 Using This Manual . . . . .	12
1.2 Quick Start Guide . . . . .	12
1.2.1 Preparations for Use . . . . .	12
1.2.2 Lock to Internal Frequency . . . . .	13
1.2.3 Lock to External Frequency . . . . .	14
1.2.4 Use with a Lock-In Amplifier . . . . .	15
<b>2 Operation</b>	<b>19</b>
2.1 Functional Overview . . . . .	20
2.1.1 Chopper Control Loop . . . . .	20
2.1.2 Chop Mode . . . . .	22
2.1.3 Shutter Mode . . . . .	25
2.2 Front Panel Control . . . . .	27
2.2.1 Power . . . . .	27
2.2.2 Numeric Display . . . . .	27
2.2.3 Configuration . . . . .	30
2.2.4 Display/Adjust . . . . .	32
2.2.5 Numeric Entry . . . . .	34
2.2.6 Phase . . . . .	35
2.2.7 Motor . . . . .	35
2.2.8 Setup . . . . .	37
2.3 Rear Panel Connections and Signals . . . . .	39
2.3.1 Source Inputs and Output . . . . .	40
2.3.2 Reference Outputs . . . . .	41
2.3.3 Synthesized Outputs . . . . .	41

<b>3</b>	<b>Remote Operation</b>	<b>43</b>
3.1	List of Commands by Subject . . . . .	44
3.2	List of Commands by Name . . . . .	46
3.3	Introduction . . . . .	48
3.3.1	Interface Configuration . . . . .	48
3.3.2	Remote Interface Buffers . . . . .	48
3.4	Commands . . . . .	48
3.4.1	Command Syntax . . . . .	48
3.4.2	Notation . . . . .	49
3.4.3	Examples . . . . .	49
3.4.4	Configuration Commands . . . . .	50
3.4.5	Chopper Operation Commands . . . . .	53
3.4.6	Setup Commands . . . . .	54
3.4.7	Interface Commands . . . . .	57
3.4.8	Status Commands . . . . .	59
3.5	Status Model . . . . .	62
3.5.1	Status Byte (SB) Register . . . . .	63
3.5.2	Service Request Enable (SRE) Register . . . . .	63
3.5.3	Standard Event Status Register (ESR) . . . . .	64
3.5.4	Standard Event Status Enable (ESE) Register . . . . .	64
3.5.5	Chopper Status (CHCR/CHEV) Registers . . . . .	65
3.6	Error Codes . . . . .	67
3.6.1	Command Execution Errors . . . . .	67
3.6.2	Command Parsing Errors . . . . .	68
3.6.3	Communication Errors . . . . .	68
3.6.4	Motor Errors . . . . .	69
3.6.5	Device-Dependent Errors . . . . .	69
3.6.6	Other Errors . . . . .	69
<b>4</b>	<b>Applications</b>	<b>71</b>
4.1	Single Beam Experiment . . . . .	72
4.2	Dual Beam Experiment . . . . .	73
4.3	Detection at Sum and Difference Frequencies . . . . .	74
<b>5</b>	<b>Troubleshooting</b>	<b>75</b>
5.1	Chopper Head Cable Shield Grounding . . . . .	75
	<b>Index</b>	<b>77</b>
	<b>Circuit Descriptions</b>	<b>81</b>
	Circuit Discussion . . . . .	82
	Motherboard . . . . .	82
	Front Panel . . . . .	83
	USB-to-Serial . . . . .	84
	Chopper Head Board . . . . .	84

---

<b>Schematic Diagrams</b>	<b>85</b>
Motherboard . . . . .	86
Motherboard Organization . . . . .	86
CPU . . . . .	87
Current Source . . . . .	88
Signal I/O . . . . .	90
Power Regulation . . . . .	91
Remote Interfaces . . . . .	92
Front Panel . . . . .	93
Front Panel Organization . . . . .	93
Front Panel Connector . . . . .	94
Front Panel Buttons . . . . .	95
Front Panel LEDs . . . . .	96
Front Panel 7-Segment Displays . . . . .	97
USB-to-Serial . . . . .	98
Chopper Head . . . . .	99



---

## General Information

---

<b>Safety and Preparation for Use</b> . . . . .	2
AC Line Voltage . . . . .	2
Line Cord . . . . .	2
Service . . . . .	2
<b>Symbols on the SR542</b> . . . . .	3
<b>Notation</b> . . . . .	3
<b>Specifications</b> . . . . .	4
Blade Specifications . . . . .	5
<b>Mechanical Dimensions</b> . . . . .	7
Controller . . . . .	7
Chopper Head . . . . .	8
Chopper Blade . . . . .	9

---

## Safety and Preparation for Use

---



### WARNING

Dangerous voltages, capable of causing injury or death, are present in this instrument. These voltages can persist for many minutes after AC power is removed. Do not remove the product covers or panels. Do not apply power or operate the product without all covers and panels in place.

---



### CAUTION

This product employs a motor capable of turning at high speeds. The rotating blade poses injury risk. Rotating parts also pose an entanglement hazard for loose clothing or long exposed hair. To prevent accidental personal injury or damage to the instrument, secure the included shroud over the chopper blade before operation.

---

## AC Line Voltage

The SR542 Precision Optical Chopper operates from a 90 V–250 V nominal AC power source having a line frequency of 50 Hz or 60 Hz.

## Line Cord

The SR542 Precision Optical Chopper has a detachable, three-wire power cord for connection to the power source and to a protective ground. The chassis of the instrument is connected to the outlet ground to protect against electrical shock. Always use an outlet which has a properly connected protective ground.

## Service

The only user-serviceable part inside the chassis is jumper J503, for selection of ground connection of the 10P10C chopper head cable shield. Please refer to Section 5.1 for instructions. Do not attempt to service or adjust this instrument unless another person, capable of providing first aid or resuscitation, is present. The SR542 Precision Optical Chopper otherwise does not have any user serviceable parts inside. Refer service to a qualified technician.

Do not install substitute parts or perform any unauthorized modifications to this instrument. Contact the factory for instructions on how to return the instrument for authorized service and adjustment.



**Symbols on the SR542**



**Warning** Risk of electric shock. Injury or death is possible if the instructions are not obeyed.



**Caution** Refer to user manual. Damage to the instrument or other equipment is possible.



**Caution** Injury is possible due to rotating parts.



**Power** Toggle instrument power.

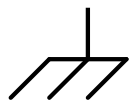

**Chassis Ground**

**Notation**

Typesetting conventions used in this manual, with examples of each.

Use case	Example
Front-panel buttons	
Front-panel text	
Remote command names	*IDN?
Literal text (sent)	*IDN?
Literal text (received)	<i>Stanford_Research_Systems,SR542,s/n00000001,v1.0.0</i>

## Specifications

### Frequency

Shaft ( $f_{\text{shaft}}$ )	0.2 Hz to 200 Hz
Chop ( $n_{\text{slots}} \times f_{\text{shaft}}$ )	0.4 Hz to 400 Hz (2-slot blade) 2 Hz to 20 kHz (10/100-slot blade)
Sources (4)	Internal Freq (0 Hz to 23.1 kHz), VCO Input, AC Line, Ext Sync (20 mHz to 23.1 kHz)
Accuracy	$\pm 20$ ppm
Stability	$\pm 20$ ppm/year
Resolution	20 $\mu$ Hz or 6 digits, whichever is greater
Multiplier, $n$	integer, 1–200
Divisor, $m$	integer, 1–200

### Phase

Resolution	0.01°
------------	-------

Jitter ( $^{\circ}$ opt, RMS)	Slot Count			
	at $f_{\text{min}}$	at $10 \times f_{\text{min}}$	at $f_{\text{max}}$	
	2	0.6° (0.4 Hz)	0.4° (4 Hz)	0.4° (400 Hz)
	5	1.0° (1 Hz)	0.5° (10 Hz)	0.4° (1 kHz)
	6	1.1° (1.2 Hz)	0.6° (12 Hz)	0.5° (1.2 kHz)
	10	1.3° (2 Hz)	0.6° (20 Hz)	0.5° (2 kHz)
	25	1.6° (5 Hz)	0.6° (50 Hz)	0.5° (5 kHz)
	30	1.9° (6 Hz)	1.0° (60 Hz)	1.0° (6 kHz)
	100	3.2° (20 Hz)	1.8° (200 Hz)	1.8° (20 kHz)

$$\text{jitter } (^{\circ}\text{opt}) = \frac{\text{jitter } (\mu\text{s})}{\text{chop period } (\mu\text{s})} \times 360^{\circ}\text{opt}$$

### Inputs (2 BNCs)

Impedance	1 M $\Omega$
VCO Voltage	0 to +10 V <sub>DC</sub>
VCO Accuracy (typ.)	$\pm 200$ ppm
Ext Sync TTL	Minimum 2 V logic level
Ext Sync Sine	100 mV <sub>RMS</sub> to 1 V <sub>RMS</sub> signal, AC-coupled (>1 Hz)
Edge Trigger	TTL Rising, TTL Falling, or Sinusoidal

### Outputs (6 BNCs)

Voltage	0 V to +5 V logic levels, sourced through 50 $\Omega$
Signals	Source, Shaft (1 PPR), Inner Slots, Outer Slots, Sum ( $f_{\text{OUTER}} + f_{\text{INNER}}$ ), Difference ( $f_{\text{OUTER}} - f_{\text{INNER}}$ )

### Operation

Control Modes	<i>Chopping</i> : synchronize Shaft, Inner, or Outer to ( $f_{\text{source}} \times \frac{n}{m}$ ) <i>Shutter</i> : fixed angular position
Remote Interface	USB type B receptacle; serial port emulation, 115,200 baud
Temperature	+10 °C to +50 °C
Power	<40 W, 90–250 V <sub>AC</sub> , 50/60 Hz

### Dimensions

Controller	8.3" $\times$ 4.1" $\times$ 9.2" (WHL)
Head with Shroud	4.31" $\times$ 4.65" $\times$ 3.75" (WHL)

### Weight

Controller	4.6 lbs
Head with Shroud	1.2 lbs

## Blade Specifications

The chopper blades designed for the SR542 are chemically etched for precision tolerancing of the beam apertures. The blade outer diameter is 4" and thickness is 0.010". For detailed dimensioning, see Figure 4. For dual-frequency blades with two tracks of slots (apertures), the tracks are referred to throughout this manual as "inner" and "outer." Note that the inner track is duplicated near the outermost circumference of the blade so that the corresponding slotted opto-interrupter on the chopper head can detect the inner slots.

**Table 1:** Available chopper blades. For dual-frequency blades, the inner and outer number of slots and maximum beam diameter are indicated as (Inner/Outer). O542DF is a variable duty factor blade, with available duty cycles from 10-90%.

Part Num	Num Slots	Max Beam Diam (in)	Chop Frequency Range (Hz)
O5422	2	1.150	0.4 – 400
O5425	5	0.873	1 – 1 k
O54230	30	0.184	6 – 6 k
O54256	5 / 6	0.626 / 0.500	1 – 1 k / 1.2 – 1.2 k
O5422530	25 / 30	0.157 / 0.184	5 – 5 k / 6 – 6 k
O54210100	10 / 100	0.358 / 0.057	2 – 2 k / 20 – 20 k
O542DF	6	0.128	1.2 – 1.2 k

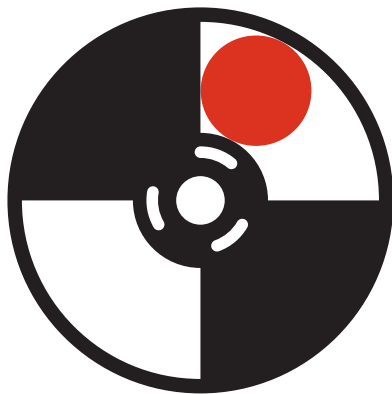

O5422 2 Slot

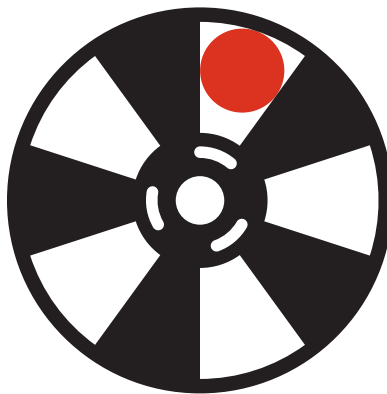

O5425 5 Slot

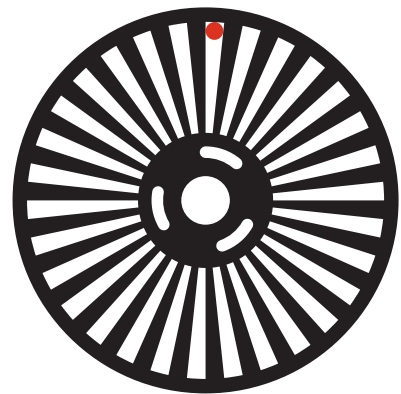

O54230 30 Slot



O54256 5/6 Slot

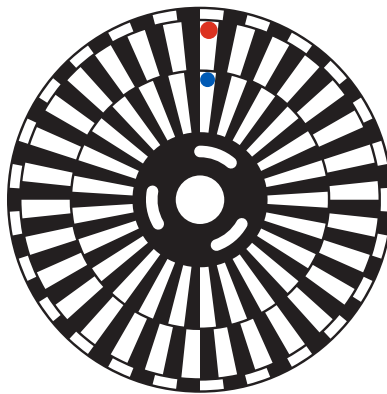

O5422530 25/30 Slot

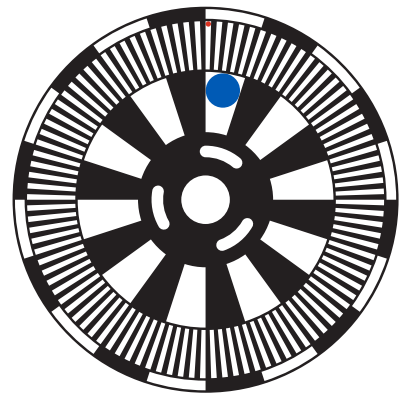

O54210100 10/100 Slot

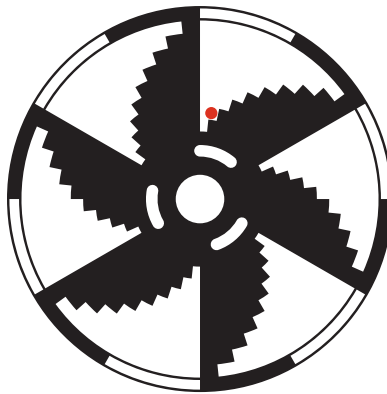

O542DF Variable Duty (10%–90%)

**Figure 1:** Available chopper blades for the SR542. Max beam size for outer (red) and inner (blue) tracks are listed in Table 1. The variable duty factor blade permits selection of duty factor from 10% to 90% in 10% increments depending on the radial placement of the beam spot.

## Mechanical Dimensions

### Controller

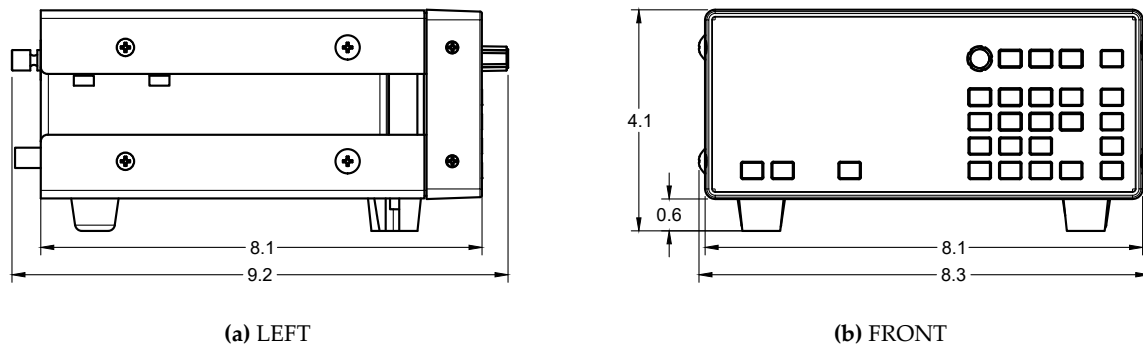

(a) LEFT

(b) FRONT

**Figure 2:** Dimensions (in inches) of the SR542 controller.

## Chopper Head

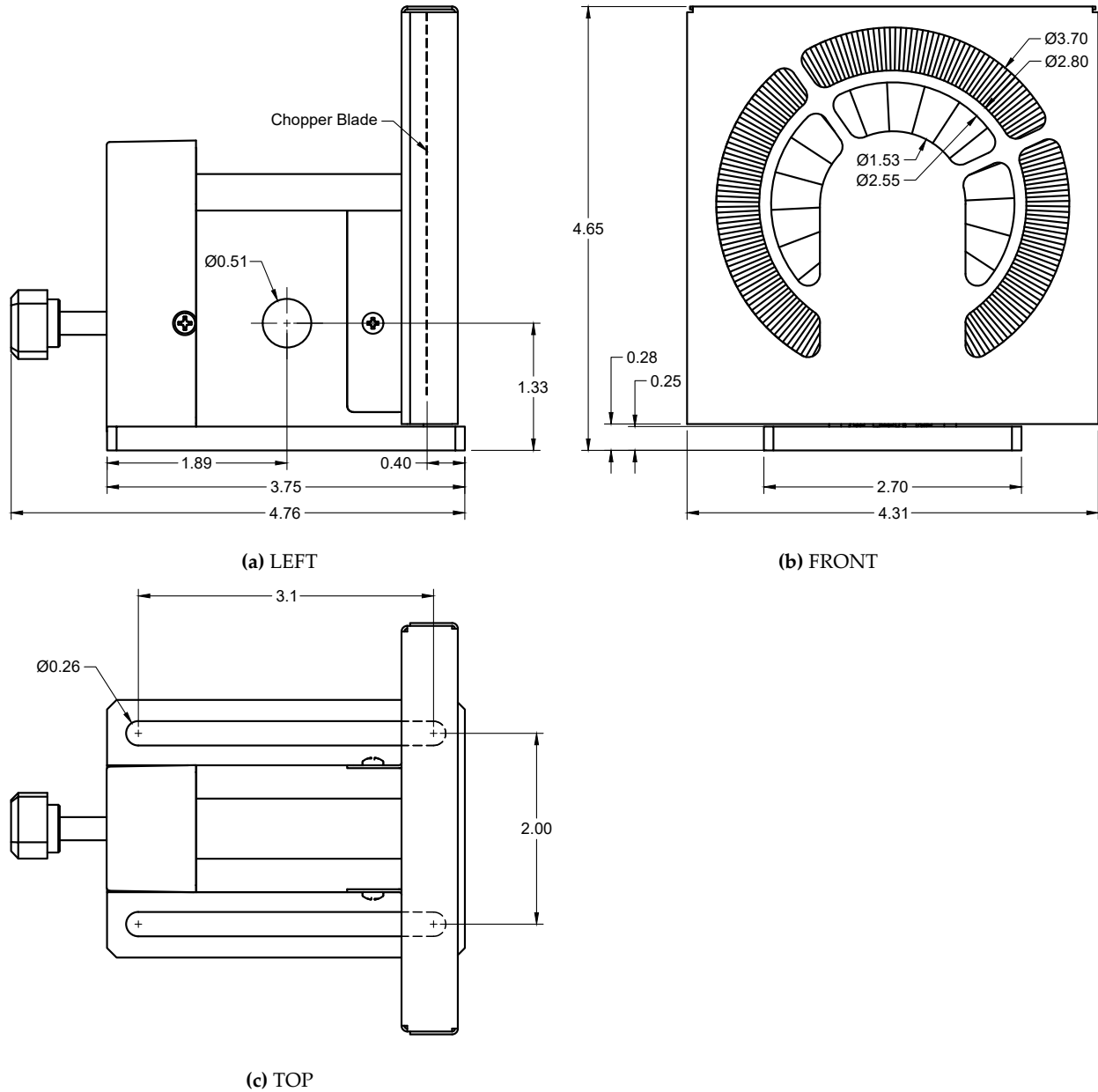

**Figure 3:** Dimensions (in inches) of the SR542 chopper head.

## Chopper Blade

The SR542 is compatible with custom designs. Figure 4 presents the critical dimensions for compatibility with the chopper hub and opto-interrupters. Single-track designs are also supported, for which the outermost aperture track is not needed. The chopper blade thickness should not exceed 0.050 in to maintain proper clearance from the slotted opto-interrupters. However, motion control is optimized for 0.010 in stainless steel blades.

The SR542 is also backwards-compatible with SR540 chopper blades. However, due to differences in the outermost aperture track, the Inner Slots Ref Out waveform, inner slots frequency, and inner slot count will be incorrect. This will also affect the sum and difference frequency outputs.

Performance specifications are not guaranteed for custom or SR540 chopper blades.

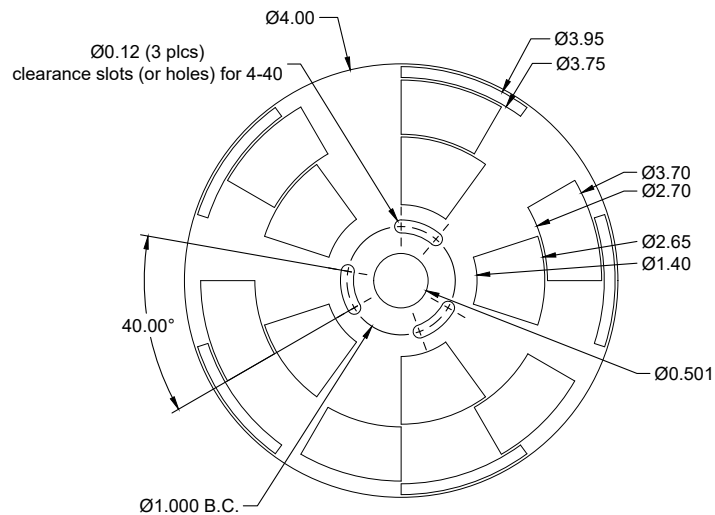

**Figure 4:** Dimensions (in inches) for the dual-track chopper blade.





---

## 1 Getting Started

---

This chapter provides step-by-step instructions to get started quickly with the SR542 Precision Optical Chopper. Refer to Chapter 2 for more detailed explanations of the features of the SR542.

<b>1.1</b>	<b>Using This Manual</b>	<b>12</b>
<b>1.2</b>	<b>Quick Start Guide</b>	<b>12</b>
1.2.1	Preparations for Use	12
1.2.2	Lock to Internal Frequency	13
1.2.3	Lock to External Frequency	14
1.2.4	Use with a Lock-In Amplifier	15
1.2.4.1	Use with SR860 and SR865A Chop Mode	17

## 1.1 Using This Manual

Two possible starting points are available to new users of the SR542. Users who wish to jump in and begin using the SR542 immediately should continue with this chapter. A series of step-by-step procedures are given for basic operation of the instrument in Section 1.2.

Those who prefer to learn the features of the SR542 with greater depth should turn to Chapter 2: Operation.

Chapter 3: Remote Operation discusses remote operation of the SR542 over the USB interface.

Chapter 4: Applications provides experimental use cases for the SR542.

Chapter 5: Troubleshooting offers troubleshooting guides for possible issues that you may encounter with the SR542.

## 1.2 Quick Start Guide

### 1.2.1 Preparations for Use

To perform the steps described in this section, you will need:

- SR542 controller and AC line cord
- SR542 chopper head and blade
- SR542 10-conductor chopper head cable

1. If a blade is not already installed, mount a blade onto the chopper hub. Be careful to slide the blade into the slotted opto-interrupters near the base before positioning the blade's inner diameter onto the hub. Secure the blade by sandwiching it between the hub and the hub plate and fasten using three 4-40 flat-head screws.
2. It is recommended to secure the chopper head before running the motor. Bolt the chopper head to the optical table using the slots in the base plate, or using a 1/2" optical post and the clamping knob.
3. Plug the AC line cord into the rear-panel power entry module of the controller and then into a grounded wall outlet.
4. Connect the included 10-conductor chopper head cable to the rear panel of the control unit and then to the chopper head.



### CAUTION

Do not use a typical 8-conductor RJ45 ethernet cable to connect the control unit to the chopper head.

5. Slide the shroud over the chopper blade and secure using two 4-40 pan-head screws.



### CAUTION

















To prevent accidental personal injury or damage to the instrument, secure the included shroud over the chopper blade before operation.

### 1.2.2 Lock to Internal Frequency

The steps below will demonstrate how to run the optical chopper, locking the chopper blade to the controller's internal frequency generator.





Beginning with the SR542 controller connected to the chopper head with the included cable and to AC power (as in Section 1.2.1):

1. Power on the control unit by pressing .
 

Most instrument settings are retained in non-volatile memory. Upon power-on, these settings are restored to their values from before the power was turned off.
2. Restore the factory-default configuration by pressing , followed by , and finally .
3. Select the **Control** track corresponding to the track of slots that will be used (Inner or Outer). Press  to toggle between  **Inner** and  **Outer** tracks. Press and hold  to select  **Shaft**.
4. Change the internal frequency by pressing  and  until the  **Int Freq** indicator is illuminated. Press  +  +  +  +  to set the Internal Frequency to 75.0 Hz.
5. When the desired configuration is established, press  to run the chopper motor. A long (~1 s) press is required to start the motor.

On startup, the SR542 first searches for the rotor shaft index, then spins the motor shaft several times to survey the installed blade before proceeding to the as-configured control parameters (frequency and phase).

The **Source Output** on the rear-panel outputs a 5 V square wave (TTL) at the selected **Source** frequency (in this case  **Internal Freq**). When the motor is running, three additional outputs are available: **Outer Slots Ref Out**, **Inner Slots Ref Out**, and **Rotor Shaft Ref Out**. Finally, once the chopper is phase locked, the sum frequency ( $f_{\text{OUTER}} + f_{\text{INNER}}$ ) and difference frequency ( $f_{\text{OUTER}} - f_{\text{INNER}}$ ) outputs are available.

When the selected control track comes into *frequency* lock with the internal frequency reference, the green  **Chopper Locked** LED will begin to flash, and the orange  **Chopper Unlocked** LED will remain illuminated. Upon acquisition of a stable *phase* lock with the reference, the green  **Chopper Locked** LED will become steadily illuminated, and the  **Chopper Unlocked** LED will turn off.







### 1.2.3 Lock to External Frequency

In this example the Ext Sync Input will be used to synchronize the optical chopper to an external reference.



To perform the steps in this section, in addition to the setup from the previous section you will need:









- an external frequency source, such as a function generator, or the reference output of a lock-in amplifier.



Beginning with the setup described in Section 1.2.1:

1. Press  to turn on the SR542.
2. Connect the external reference signal to the Ext Sync Input connector on the rear panel using a standard BNC cable (not included).
3. Press  repeatedly to until  is selected as the source.
4. Press  repeatedly to select the desired edge triggering. Select  or  for a TTL reference, or  for a sinusoidal reference.



For TTL inputs, a minimum >2V logic level is required. For sinusoidal inputs, an amplitude of at least 100 mV<sub>RMS</sub> and frequency greater than ~1 Hz is required.



The  indicator should illuminate within about three periods of the reference frequency. If  does not light or does not remain lit, check the quality of the external signal.

5. Use  and  to show the  frequency monitor on the numeric display and verify that the frequency matches that of the external reference.
6. Configure the  track by pressing  until the desired track is selected. To select , press and hold .
7. Press and hold  until the motor starts.

The  indicator should remain lit and the  indicator will begin to flash indicating the motor has achieved the correct speed, and then light solid once the phase is locked.

8. Change the frequency of the external source by a few percent.

The  light will go out indicating that the internal clock is no longer locked to the external frequency. Until the internal clock can lock to the new frequency, the chopper will continue to run at the previous frequency and  may remain lit.

Once *both*  and  indicators are lit, the chopper is properly phase locked to the external reference.







### 1.2.4 Use with a Lock-In Amplifier

The SR542 can be used with a lock-in as a *follower* or a *reference*. To *follow* the lock-in, simply connect the reference output from the lock-in to the Ext Sync Input of the SR542 as described above in Section 1.2.3: Lock to External Frequency. Alternatively, the lock-in can follow the SR542 as described here. In this example, Outer Slots Ref Out is used as the reference signal input to the lock-in amplifier.

To perform the steps in this section, in addition to the setup from the previous sections you will need:

- a lock-in amplifier (e.g. SR860)
- a light source (optional)
- a photodiode, phototransistor, or other light-sensitive detector

Beginning with the setup described in Section 1.2.1:

1. Select ● Internal Freq as the Source by pressing  repeatedly.
2. Select ● Outer as the Control by pressing  repeatedly.
3. Set the internal frequency to 75 Hz by selecting ● Int Freq with  and  and then entering  +  + .
4. Connect the Outer Slots Ref Out from the rear panel of the SR542 to the reference input of the lock-in amplifier using a standard BNC cable (not included).
5. Configure the lock-in reference settings to use an external reference with TTL input and 50  $\Omega$  termination, if available.

The Outer Slots Ref Out signal is derived from an opto-interrupter and is not available until the chopper is running. As a result, the lock-in amplifier will not yet be able to lock to this signal.

6. Press and hold  until the chopper starts.

Now the lock-in amplifier should be able to lock to the Outer Slots Ref Out signal.

7. Connect the photodiode to the lock-in input and position the photodiode lens near the chopper blade.

A light source, such as a laser, can be used to illuminate the photodiode detector through the chopper blade but ambient light can often produce a large enough signal if the detector is placed very close to the blade.



8. Adjust the lock-in sensitivity until a signal is visible.

The lock-in is measuring the component of the photodiode signal at the frequency provided by the Outer Slots Ref Out. This signal is produced by the taller opto-interrupter at the base of the chopper head. Because the photodiode is at a different position from the interrupter, there will be a phase difference of  $\phi_{\text{detector}} = n \times 360^\circ + \phi_{\text{offset}}$ , where  $n$  is the integer number of slots between the opto-interrupter and the photodiode.

In most cases it is desirable to adjust for  $\phi_{\text{offset}}$  (the  $n \times 360^\circ$  term can be neglected). This can be achieved by adjusting the phase on the lock-in.



9. Adjust the phase of the lock-in so that the entire signal appears on the first channel (Ch 1 or X on most two-phase lock-ins). On the SR860 lock-in, simply press .

The phase difference between the photodetector and the opto-interrupter signals is a result of the relative physical positions of those detectors around the chopper blade and cannot be adjusted by a setting on the SR542. Increasing the phase setting of the SR542 does advance the phase of the photodetector signal, but it advances the phase of the opto-interrupter signal—used by the lock-in as its reference—by an identical amount.

10. Set the  of the SR542 to  $15^\circ$  and notice that the signal on the lock-in does not change.
11. Set the  of the SR542 to  $0^\circ$ .
12. Now disconnect the BNC cable from the Outer Slots Ref Out and connect it instead to the Source Output.

The phase of the lock-in signal is now offset by the phase difference between the Source Output and the opto-interrupter.

13. Change the  of the SR542 and notice that the same change appears on the lock-in.

Source Output provides a signal with the same average frequency as the selected  track and its corresponding rear panel output (Outer Slots Ref Out or Inner Slots Ref Out), so long as the  is set for . However, the signals produced by the opto-interrupters (Outer Slots Ref Out and Inner Slots Ref Out) are the most accurate representations of the modulation imposed on a beam path through the outer and inner tracks, respectively. Therefore, it can be advantageous to use these outputs as the lock-in reference input.

#### 1.2.4.1 Use with SR860 and SR865A Chop Mode

The SR860 and SR865A lock-ins can be configured for Chop mode, which provides phase-locked loop control of the legacy SR540 optical chopper, which otherwise runs “open loop.” While measuring the SR540 chop frequency and phase with its Ref In, the lock-in “closes the loop” by outputting a DC control voltage to the VCO Input of an SR540. This control loop is specifically tuned for the SR540 and will not provide stable control of an SR542.

Since the SR542 implements closed-loop control on its own, there is no advantage to controlling it via the SR860 or SR865A Chop mode. Instead, follow the directions above to use the SR542 as either a *follower* of the lock-in or a *reference* to the lock-in. If VCO control of the SR542 is needed, the lock-in Aux outputs can set to output a steady DC voltage.





---

## 2 Operation

---

This chapter provides an in-depth look at operation of the SR542.

<b>2.1</b>	<b>Functional Overview</b>	<b>20</b>
2.1.1	Chopper Control Loop	20
2.1.2	Chop Mode	22
2.1.2.1	Shaft Control	22
2.1.2.2	Blade Control: Inner Slots	23
2.1.3	Shutter Mode	25
<b>2.2</b>	<b>Front Panel Control</b>	<b>27</b>
2.2.1	Power	27
2.2.2	Numeric Display	27
2.2.2.1	Frequency Monitor	28
2.2.2.2	Settings	29
2.2.3	Configuration	30
2.2.3.1	Frequency Source	30
2.2.3.2	Edge	31
2.2.3.3	Multiplier	31
2.2.3.4	Control	32
2.2.3.5	Chopper Locked Status	32
2.2.4	Display/Adjust	32
2.2.5	Numeric Entry	34
2.2.6	Phase	35
2.2.7	Motor	35
2.2.8	Setup	37
2.2.8.1	Save	37
2.2.8.2	Recall	38
2.2.8.3	Back	38
<b>2.3</b>	<b>Rear Panel Connections and Signals</b>	<b>39</b>
2.3.1	Source Inputs and Output	40
2.3.1.1	VCO Input	40
2.3.1.2	Ext Sync Input	40
2.3.1.3	Source Output	40
2.3.2	Reference Outputs	41
2.3.2.1	Outer Slots Ref Out	41
2.3.2.2	Inner Slots Ref Out	41
2.3.2.3	Rotor Shaft Ref Out	41
2.3.3	Synthesized Outputs	41
2.3.3.1	$f_{\text{OUTER}} + f_{\text{INNER}}$	41
2.3.3.2	$f_{\text{OUTER}} - f_{\text{INNER}}$	41

## 2.1 Functional Overview

Optical choppers provide an economical and easy-to-use method for introducing a square- or rectangular-wave amplitude modulation to an optical signal. Well-defined signal modulation permits synchronous detection (e.g. with a lock-in amplifier) to identify weak signals in the presence of noise and large background.

The SR542 provides optical modulation from 0.4 Hz to 20 kHz. By employing a brushless, slotless DC motor, mechanical vibrations and phase jitter are dramatically reduced. A brushless motor also extends the operating life of the chopper, as compared to brushed motor designs in which the commutation contacts can wear out.

Key features of the SR542 include:

- wide range of chopping frequencies
- $\pm 20$  ppm frequency accuracy
- phase locking to external signals (e.g. provided by lock-in amplifier, function generator, or another chopper)
- frequency control by external DC voltage (VCO mode)
- phase locking to AC line
- low phase jitter
- long-life brushless motor
- single and dual beam experiments
- sum and difference frequency reference outputs
- harmonic, sub-harmonic, and fractional harmonic phase locking
- adjustable and reproducible phase, including settable relative phase, with  $0.01^\circ$  resolution
- shutter mode (fixed position)
- full remote operation by USB interface
- non-volatile memory for nine (9) user-defined instrument configurations

### 2.1.1 Chopper Control Loop

Figure 2.1 depicts the control loop responsible for driving the chopper motor at the appropriate frequency and phase to achieve lock with the chosen reference. The user selects from four frequency references (the **Source**): Internal Freq, VCO Input, AC Line, and Ext Sync.

The selected source determines the frequency of the Source Clock. The Source Clock frequency is set directly in Internal Freq and VCO Input modes by the **Int Freq** setting or DC voltage supplied to VCO Input, respectively. For AC Line or Ext Sync modes, the Source Phase-Locked

Loop (PLL) uses PID control to minimize the phase difference  $\Delta\phi$  between the input signal and the Source Clock. The Source Clock is made available as a 50% duty cycle 5 V logic signal at the Source Out BNC on the rear panel.

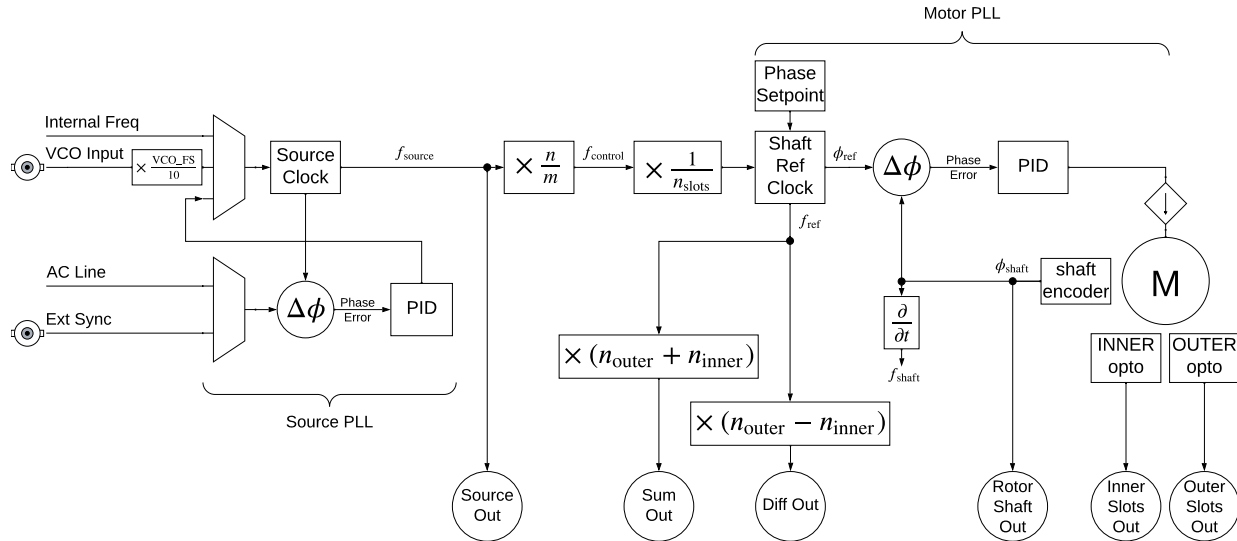

**Figure 2.1:** Block diagram of the chopper control loop. Signal inputs (Ext Sync and VCO Input) are shown at the top left. Signal outputs are shown along the bottom.

From the Source Clock, several other clocks are derived. The first of these—the Shaft Reference Clock—provides a reference signal to the Motor PLL, which uses another PID controller to calculate the motor drive current necessary to lock the chopper. Specifically, the Motor PLL will work to bring  $f_{\text{shaft}} = f_{\text{source}} \times \left(\frac{n}{m} \frac{1}{n_{\text{slots}}}\right)$  and  $\phi_{\text{shaft}} = \phi_{\text{setpoint}}$ . An optical encoder affixed to the rear shaft of the chopper motor is used to measure  $\phi_{\text{shaft}}$  and  $f_{\text{shaft}}$ .

Also available to the user via remote query is  $(f_{\text{source}} \times \frac{n}{m})$ . This is the target control frequency for the selected **Control** track (see MFRQ?).

Finally, when used with a dual-frequency chopper blade, the SR542 synthesizes square wave reference outputs at  $(f_{\text{OUTER}} + f_{\text{INNER}})$  (sum) and  $(f_{\text{OUTER}} - f_{\text{INNER}})$  (difference). These references can be used for non-linear mixing experiments (e.g. a non-linear sample excited simultaneously at  $f_{\text{INNER}}$  and  $f_{\text{OUTER}}$  will respond at sum and difference frequencies). For a detailed example, see Section 4.3.

Other available outputs on the rear panel are produced by optical sensors on the chopper head itself: Inner Slots Ref Out and Outer Slots Ref Out are generated by slotted opto-interrupters at the base of the chopper head, and Rotor Shaft Ref Out is generated by the shaft encoder.

### 2.1.2 Chop Mode

Chop mode refers to the standard use case of an optical chopper in which the motor runs at a steady rate in order to provide a chopped optical signal with the appropriate frequency and phase.

It is instructive to consider in detail the meaning of phase under various instrument configurations. For all of the following examples, we use the O54256 5/6 slot dual-frequency blade, with the shaft encoder index position arbitrarily oriented at  $+54^\circ\text{mech}$  relative to the coincident inner and outer track edges, as depicted in Figure 2.2. The shaft encoder produces a once-per-revolution pulse (output high), with a duration of  $1/400^{\text{th}}$  of a mechanical revolution, as the index position rotates through the encoder's optical sensor. The pulse is available at Rotor Shaft Ref Out.

A mechanical rotation of  $360^\circ\text{mech}/n_{\text{slots}}$  is equivalent to a full  $360^\circ\text{opt}$  cycle.

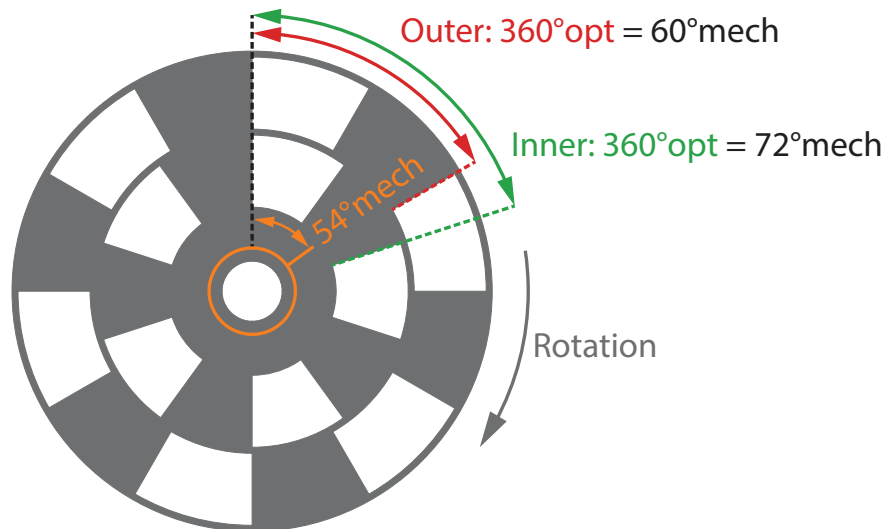
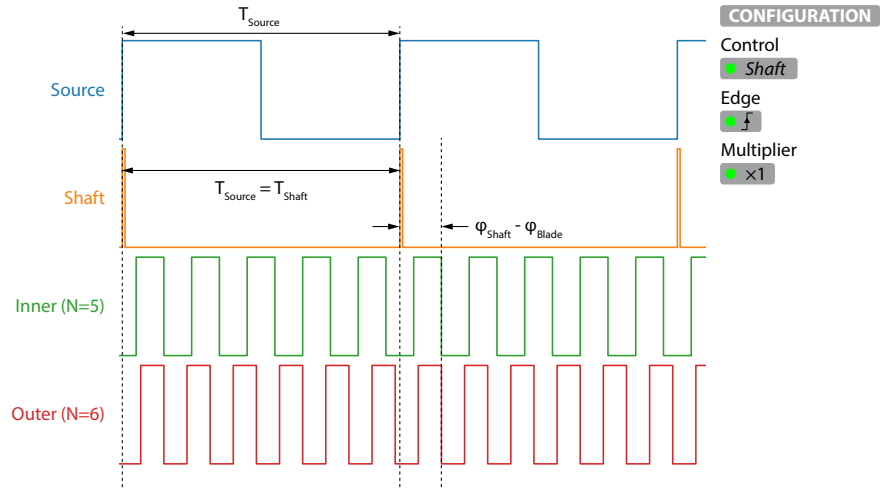

**Figure 2.2:** Relationship between optical and mechanical degrees ( $^\circ\text{opt}$  and  $^\circ\text{mech}$ ) for O54256 5/6 slot dual-frequency blade. Positive rotation of the chopper blade is clockwise when viewed from the front of the chopper head. The shaft encoder index orientation (which is *not* a feature of the chopper blade itself, and will generally vary for any given chopper head unit) is shown in orange. For ease of comparison to the timing diagrams below, the index orientation is measured relative to the coincident edges of the inner and outer tracks (leading by  $+54^\circ\text{mech}$  in this example).

#### 2.1.2.1 Shaft Control

First consider the instrument configuration and timing diagram of Figure 2.3, in which the SR542 is configured to control the  $\bullet$  Shaft, with a frequency Multiplier of  $\bullet \times 1$ . The Rotor Shaft Ref Out (one-pulse-per-

revolution) is frequency-locked to the Source Output waveform, with a **Phase** setting of  $0^\circ$ . With the O54256 5/6 slot dual-frequency blade, the Inner Slots Ref Out produces a waveform at  $5 \times f_{\text{shaft}}$  and Outer Slots Ref Out at  $6 \times f_{\text{shaft}}$ . The systematic phase offset  $\phi_{\text{shaft}} - \phi_{\text{blade}}$  ( $54^\circ$  mech in this example) between Rotor Shaft Ref Out and the Inner/Outer Slots Ref Out signals exists due to the installed orientations of the shaft encoder and chopper blade.<sup>1</sup>



**Figure 2.3:** Simulated timing diagram of rear-panel outputs for *Shaft* control with  $0^\circ$  phase offset. Width of Rotor Shaft Ref Out pulse is exaggerated for illustrative purposes.

The next example, shown in Figure 2.4, is identical to Figure 2.3 except that a  $-90^\circ$  phase offset has been added by programming the **Phase** setting available to the user. The sign of this phase offset indicates that the controlled track will *lag* the Source by  $90^\circ$ .

### 2.1.2.2 Blade Control: Inner Slots

If the **Control** is changed to **Inner**, then the Inner Slots Ref Out will be frequency and phase-locked to the Source Output as is shown in Figure 2.5. As shown by the block diagram in Figure 2.1, the chopper is always controlled using the shaft encoder signal (with a phase and frequency appropriately scaled by  $n_{\text{slots}}$ , the number of slots of the selected **Control** track). For control of  $n_{\text{slots}} = 5$ , the shaft frequency will be locked to  $f_{\text{source}}/5$ . Together with a phase setpoint of  $0^\circ$ , this will result

<sup>1</sup> The blade feature corresponding to coincident falling edges of the Inner and Outer reference signals was chosen as an easy-to-recognize reference point from which to measure the shaft offset. This offset depends on the factory-installed shaft encoder orientation and the user-installed blade orientation, and in general will vary from  $54^\circ$  mech. Furthermore, due to lateral offsets of the opto-interrupters which produce Inner Slots Ref Out and Outer Slots Ref Out, the phases of the Inner and Outer signals will be shifted slightly in comparison to the simplified timing diagrams shown here.

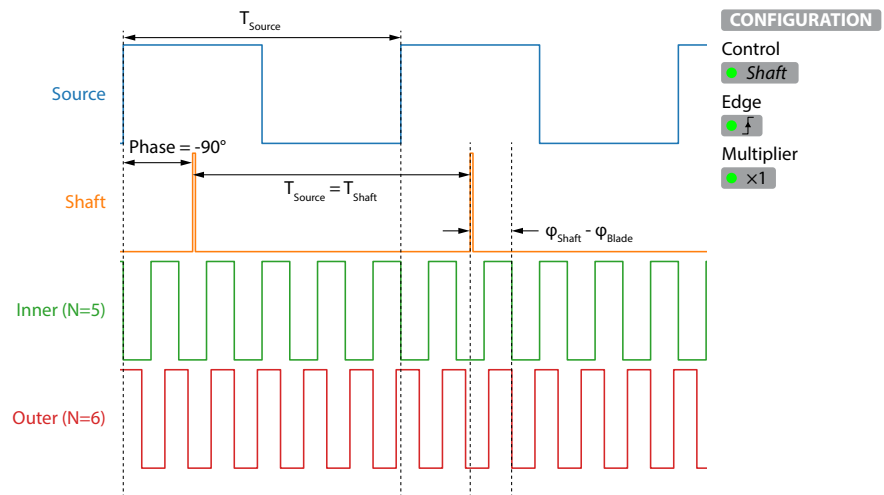

**Figure 2.4:** Simulated timing diagram of rear-panel outputs for *Shaft* control with  $-90^\circ$  phase offset. Width of Rotor Shaft Ref Out pulse is exaggerated for illustrative purposes.

in every fifth rising edge of Source Output to be aligned to the rising edges of Rotor Shaft Ref Out. The same systematic offset  $\phi_{\text{shaft}} - \phi_{\text{blade}}$  described above will still be present.

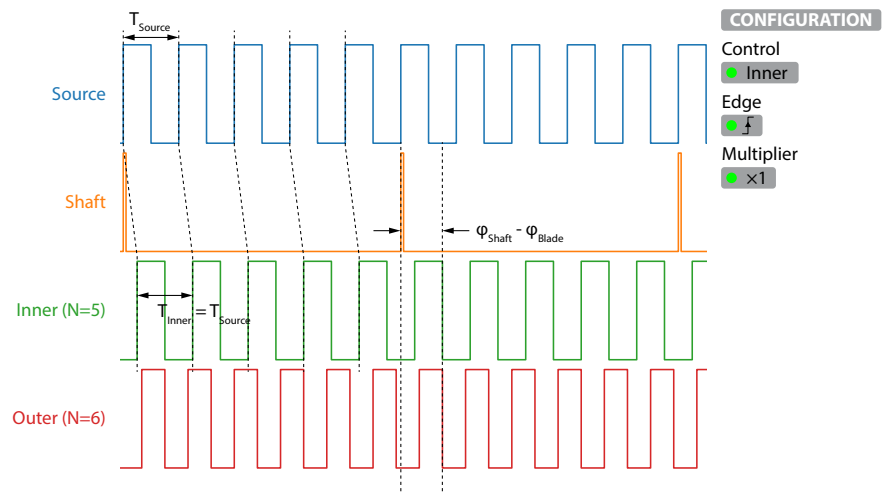

**Figure 2.5:** Simulated timing diagram of rear-panel outputs for Inner Slots control with  $n_{\text{slots}} = 5$  and  $0^\circ$  phase offset. Width of Rotor Shaft Ref Out pulse is exaggerated for illustrative purposes.

By properly adjusting the **Phase** setting of the Inner track, the user can correct for this systematic phase offset. Figure 2.6 shows that by adjusting the phase setpoint to  $+90^\circ$ , the Inner Slots Ref Out can be brought into phase alignment with Source Out. This amounts to a mechanical phase advanced of  $+18^\circ$  mech.

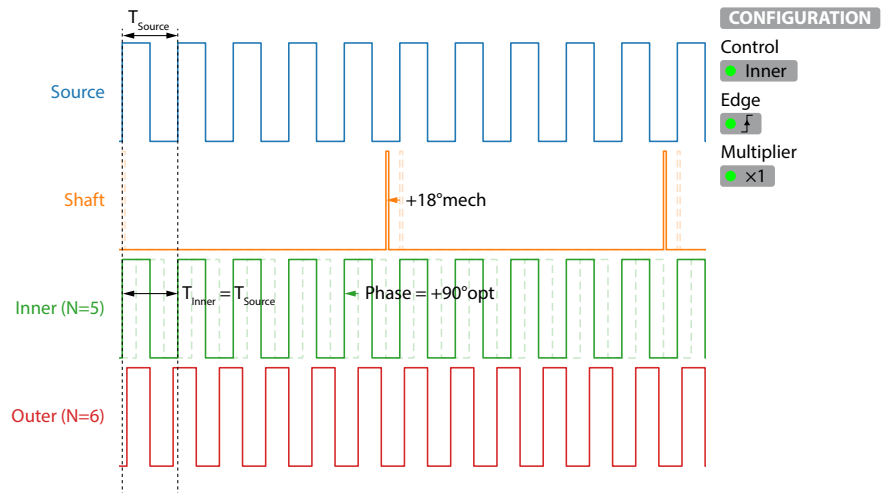

**Figure 2.6:** Simulated timing diagram of rear-panel outputs for Inner Slots control with  $n_{\text{slots}} = 5$  and  $+90^\circ$  phase offset. The Rotor Shaft Ref Out and Inner Slots Ref Out signals with a  $0^\circ$  phase offset from Figure 2.5 are shown as faint dashed lines for easy comparison. Width of Rotor Shaft Ref Out pulse is exaggerated for illustrative purposes.

The user's own chopped optical signal will likely experience a different, but still systematic, offset relative to Source Out, owing to the difference in position between the inner track slotted opto-interrupter and the user's beam path.

Once the **Phase** setpoint has been adjusted to provide the desired offset between the source and control signals, that phase can be set as the  $0^\circ$  reference point (to which further adjustments are relative) by pressing



### 2.1.3 Shutter Mode

In addition to the traditional *chop mode*, the SR542 can be used as an optical shutter. While not to be used for precisely timed signals (see the SR475 Laser Shutter for such applications), *shutter mode* can be useful for temporarily blocking or unblocking the beam path to test optical alignment or signal levels, or for prohibiting downstream exposure to the blocked beam.

To configure the the SR542 for *shutter mode*, choose **Internal Freq** as the **Source**, and set **Int Freq** to 0 Hz. In this mode, the chopper blade is held in a fixed (static) position, with angular orientation set by the **Phase** setting.

To understand this mode of operation, Figure 2.7 provides an example case with the SR542 controlling the position of the Outer slots. By changing the **Phase** from  $0^\circ$  to  $180^\circ$  the user can alternately pass or block the

optical beam. Note that a change of  $180^\circ_{\text{opt}}$  when controlling the outer track of this 6-slot blade corresponds to a  $30^\circ_{\text{mech}}$  rotation.

Because the angular orientation of the chopper blade in  $^\circ_{\text{opt}}$  spans the range from  $[0^\circ; n_{\text{slots}} \times 360^\circ)$ , the front-panel display of the phase setting in *shutter mode* is given as a combination of slot number  $N$   $[0, n_{\text{slots}}-1]$  and angle remainder  $D$   $[0^\circ; 360^\circ)$ , such that:

$$\text{Phase}(^\circ) = N \times 360^\circ + D(^\circ) \quad (2.1)$$

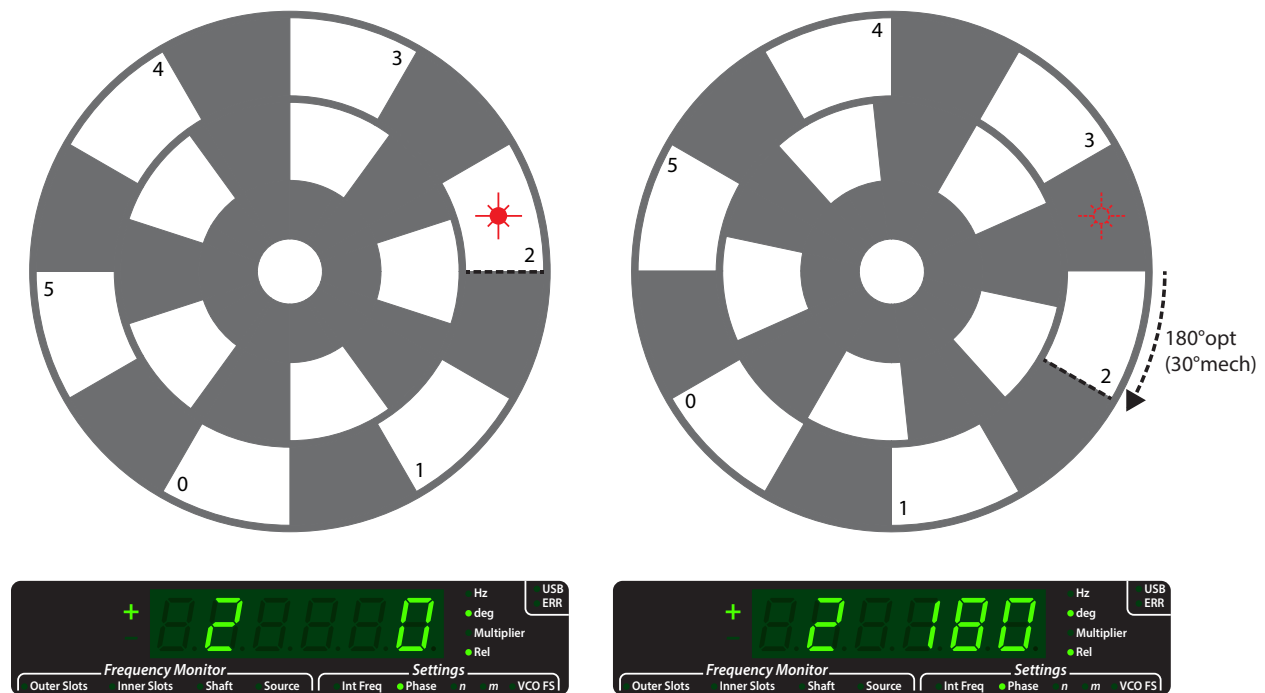

**Figure 2.7:** With **Source** = ● Internal Freq and **Int Freq** = 0 Hz, the SR542 enters *shutter mode*, which keeps the chopper blade in a fixed position as determined by the ● Phase setting. The ● Phase display in this mode presents an integer slot number  $N$  and angle  $D$ , where the phase setpoint =  $(N \times 360^\circ) + D$ . LEFT:  $N = 2, D = 0^\circ$  RIGHT:  $N = 2, D = 180^\circ$

The shaft encoder installed on the chopper head has a mechanical resolution of  $0.9^\circ_{\text{mech}}$ . In *shutter mode*, rotations less than that are not achievable. In *chop mode*, the controller CPU uses timing information from the shaft encoder signals to achieve more precise phase control.



## 2.2 Front Panel Control

The SR542 front panel is organized into seven functional blocks which are described in this chapter: Numeric Display, Configuration, Display/Adjust, Phase, Numeric Entry, Motor, and Setup. The front panel is shown in Figure 2.8.

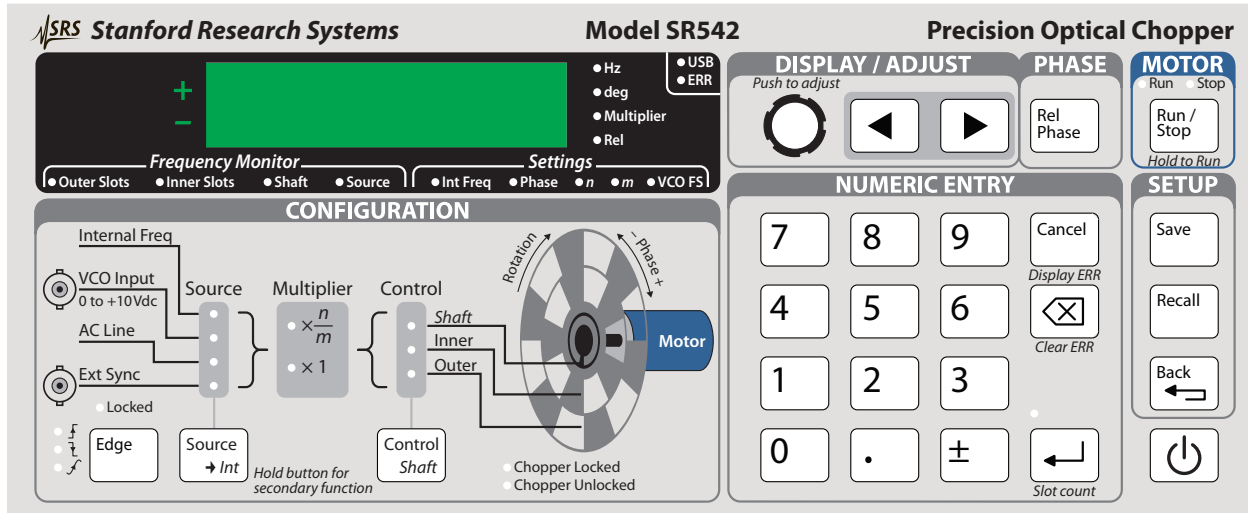





Figure 2.8: The SR542 front panel.

### 2.2.1 Power

The  button is used to turn the SR542 controller On and Off.

### 2.2.2 Numeric Display

At the top left of the front panel is a 6-digit numeric display which displays the parameter indicated by the **Frequency Monitor** or **Settings** LEDs. **Frequency Monitor** selections display frequencies *measured* by the control unit, while **Settings** selections display variables that can be *set* by the user. Units are indicated according to the displayed parameter (**Hz**, **deg**, **Multiplier**, or **Rel**), and if the parameter is signed, the appropriate sign LED will light.



The user can scroll between the **Frequency Monitor** and **Settings** modes using the  and  buttons.

In the top right corner of the numeric display are indicators for remote interface activity (**USB**) and errors present in the error buffer (**ERR**). For more information on the error buffer, see Section 3.6.

### 2.2.2.1 Frequency Monitor

There are four **Frequency Monitor** display modes. The numeric entry keypad and rotary knob are disabled in these modes.

- 
- **Outer Slots** Displays the instantaneous measured frequency of the chopper blade outer slots.
  - **Inner Slots** Displays the instantaneous measured frequency of the chopper blade inner slots. Displays *not* for single-track blades.
  - **Shaft** Displays the instantaneous measured frequency of the motor shaft (in mechanical revolutions per second).
  - **Source** Displays the frequency of the Source Clock.
- 

*Slot count* When the front panel is configured to display ● **Outer Slots**, ● **Inner Slots**, or ● **Shaft** frequency, a press-and-hold of the  button will display the number of slots on the corresponding track until the button is released. For example, with the 10/100 slot blade installed, and **Frequency Monitor** set to ● **Outer Slots**, holding the  down will display:



Releasing  will return the display to frequency monitoring.

## 2.2.2.2 Settings

In the five **Settings** modes, the numeric display presents an adjustable parameter. In these modes, numeric entry buttons are enabled for user input. The rotary knob, activated by a knob press, can be used to increment or decrement individual digits.

- 
- Int Freq** Set the frequency (in Hz) of the internal oscillator (0 Hz – 23.1 kHz).
  - Phase** Set the phase (in degrees) of the selected control track relative to the frequency source. Sets the *Rel Phase* when the **Rel** indicator is lit. See Section 2.2.6.
  - n** Set the frequency multiplier,  $n = 1, 2, 3, \dots 200$ . See Multiplier.
  - m** Set the frequency divisor,  $m = 1, 2, 3, \dots 200$ . See Multiplier.
  - VCO FS** Set the full-scale range over which the internal oscillator is tuned as the VCO input varies from 0 V–10 V<sub>DC</sub>.
- 

The **Phase** setting is always presented in units of  $^{\circ}\text{opt}$ , where  $360^{\circ}\text{opt}$  corresponds to one cycle of the selected **Control** track. (In **Shaft** control,  $360^{\circ}\text{opt}$  is equivalent to  $360^{\circ}\text{mech}$ , since  $n_{\text{slots}} = 1$  for calculational purposes). The phase setting entered by the user is mapped to the range  $n_{\text{slots}} \times (-360^{\circ}, +360^{\circ})$  using modulo division before being stored internally.

In *chop mode*, the **Phase** displayed on the front panel will undergo another modulo operation (modulo  $360^{\circ}$ ), to present the optical phase from  $-359.99^{\circ}$  to  $359.99^{\circ}$ .

In *shutter mode*, the phase will be displayed in the range  $[0^{\circ}, n_{\text{slots}} \times 360^{\circ})$ . This shutter phase will be rendered with two digits for the slot number  $[0, n_{\text{slots}} - 1]$  and three digits for the optical phase  $[0^{\circ}, 360^{\circ})$ . For example, with  $n_{\text{slots}} = 5$ , a **Phase** setting of  $735^{\circ}$  will be rendered as



(since  $2 \times 360^{\circ} + 15^{\circ} = 735^{\circ}$ ).

Entry of the phase setpoint in *shutter mode* either by numeric keypad or remote command expects a single value in  $^{\circ}\text{opt}$ . However, the phase value displayed on the front panel (as slot number + angle remainder) can be directly edited via the rotary encoder knob (either the slot number or the angle remainder digits can be selected for direct editing).

Regardless of operating mode the remote query PHAS? will always respond with internally stored phase in the range  $n_{\text{slots}} \times (-360^\circ, +360^\circ)$ .

## 2.2.3 Configuration

The **CONFIGURATION** block provides a simplified block diagram of the chopper control loop (See Section 2.1.1 for detailed discussion). This block indicates the frequency **Source**, the edge or trigger slope, the frequency **Multiplier**, and the **Control** track to be phase locked.

### 2.2.3.1 Frequency Source

The frequency source to which the Source Clock is phase-locked can be selected from:

- Internal Freq
- VCO Input
- AC Line
- Ext Sync

The selected source is indicated by the **Source** LEDs. The  button is used to select the frequency source. Single button presses scroll top-to-bottom through the available sources.

When  AC Line or  Ext Sync are the selected source, the  Locked LED indicates that the control unit has successfully phase locked to the AC Line signal or the signal provided at the Ext Sync Input on the rear panel. If the  Locked indicator is not stable, the external signal may be too noisy, small, or out of range.  Locked indication is independent of the chopper motor, and *does not* imply that the chopper blade has been successfully locked to the external signal (see Section 2.2.3.5: Chopper Locked Status).

If  Ext Sync is selected as the source and the signal at the Ext Sync Input exceeds 23.1 kHz, the  Ext Sync source LED will flash.

If  VCO Input is selected as the source and the VCO Input voltage results in a source frequency that exceeds 23.1 kHz, the  VCO Input source LED will flash. Reduce the **VCO FS** setting or the input voltage.

*Jump to Int* For all sources other than  Internal Freq, a long press (~1 s) of  will copy the most-recently estimated Source frequency to the **Int Freq** setting, and the **Source** will jump to  Internal Freq. The Source Clock will then proceed at that stable, fixed frequency.

The *Jump to Int* feature could be useful to diagnose a noisy Ext Sync signal which the SR542 has difficulty tracking with its Source PLL.

With the exception of the *Jump to Int* function, it is not possible to modify the **Source** while the motor is on.

### 2.2.3.2 Edge

When using **Ext Sync** to control the chopper, the control unit can trigger on the following edges:

- f** Rising TTL
- ∩** Falling TTL
- ∩** Sine

Use the **Edge** button to select from the three available edge types. The button scrolls through the options from top-to-bottom.

It is generally advantageous to provide rectangular-wave TTL signals to the Ext Sync input, as a sharp edge is less corruptible by noise than a slowly ramping sinusoid (especially for input frequencies less than 1 kHz). Furthermore, the Source Clock will experience a frequency- and amplitude-dependent phase shift relative to a sinusoidal input signal due to the circuitry responsible for **∩** edge detection.

Edge selection has no impact when **Source** is not set to **Ext Sync**. The edge indicator LEDs will turn off, and the **Edge** button will be deactivated.

### 2.2.3.3 Multiplier

The **Multiplier** sub-block of the **CONFIGURATION** section indicates whether the user has selected either  $n$  or  $m \neq 1$ . If  $n = m$ , then the **×1** indicator will light. Otherwise, the **× $\frac{n}{m}$**  indicator will light.

Certain choices of  $n$  and  $m$  may result in a Maximum Frequency error. If the motor is already running (therefore the slot counts have already been surveyed) illegal values for  $n$  and  $m$  will be rejected with a *Probib* message. If the motor is off, all values of  $n \leq 200$  and  $m \leq 200$  will be accepted, since  $n_{\text{slots}}$  is not yet known. On the next motor startup the slot counts will be surveyed. If the frequency of the Shaft Reference Clock (see Figure 2.1) exceeds the maximum permissible frequency, startup will be aborted, a maximum frequency error will be recorded, and *FreqErr* will be temporarily displayed.



### 2.2.3.4 Control

The **Control** target indicates which periodic feature will be frequency- and phase-locked to the selected **Source**. The user can select from:

● **Shaft**

● **Inner**

● **Outer**

The  button is used to select the **Control** target. Brief presses of  toggle between ● **Inner** and ● **Outer** tracks. To select ● **Shaft** as the **Control** target, hold  for 1 second.

The timing diagrams given in Section 2.1.2 demonstrate phase locking to the various **Control** targets.



It is not possible to modify the **Control** while the motor is running.



### 2.2.3.5 Chopper Locked Status



A pair of LEDs indicate the frequency and phase lock status of the controlled chopper track. When the track is neither frequency nor phase locked, only the orange ● **Chopper Unlocked** LED will be lit. As the motor spins up to speed and the chopper comes into frequency lock (frequency of the selected **Control** matches  $(f_{\text{source}} \times \frac{n}{m})$ ), the green ● **Chopper Locked** LED will begin to flash. Finally, once phase lock is achieved, the ● **Chopper Locked** LED will remain steadily on, and the ● **Chopper Unlocked** LED will turn off.

Both the frequency and phase lock status are available as status bits in the CHCR register (see Section 3.5.5.1).

## 2.2.4 Display/Adjust

The **DISPLAY / ADJUST** block of the front panel consists of a rotary knob and left/right select buttons:  and .

The  and  buttons are typically used to scroll through the **Frequency Monitor** and **Settings** modes of the main display.



At power-on, the rotary knob is not active. To use the rotary knob, briefly press the knob inwards. The ones digit (or most recently adjusted) digit will begin to blink, indicating the digit is selected for adjustment by turning the knob. When a digit is blinking (knob is active),  and  are used to choose which digit is controlled by the knob. Knob functionality can be canceled by pressing the knob again, or by pressing

. Any numeric entry button will also cancel the knob functionality and begin numeric entry instead.



The knob can only be activated to adjust **Settings** and will not respond when showing **Frequency Monitor** selections.



*Audio Settings* Front-panel adjustment of the audible alarm and key click settings can be accessed by a long-hold (~1 s) of the rotary knob. This will initially display the alarm setting, which controls whether the SR542 emits an audible alarm when an error is encountered. The factory-default alarm setting is ON (1). The front-panel display will show:



The  and  buttons can be used to select either the alarm setting or the key click setting. The key click setting controls whether front-panel button presses and knob operations emit an audible “click,” and also defaults to ON (1). The key click menu is displayed as:



When the alarm or key click menus are active, the corresponding setting can be modified with  and  (OFF and ON, respectively), or with the rotary knob (following a short-press to activate digit edit). A setting change occurs immediately, and does not require confirmation with a press of .

Other buttons (e.g.  or ) will exit the audio menus and return to the previous front-panel display mode.

The alarm and key click settings are saved to non-volatile memory and restored at power-on, and can also be modified (and queried) with the remote commands ALRM(?) and KCLK(?).

## 2.2.5 Numeric Entry

The **NUMERIC ENTRY** keypad is used to directly enter numeric values for the various settings of the SR542. Values are implicitly positive unless the  $\pm$  button is pressed, which will toggle the sign between positive and negative. (**Phase** is the only parameter which accepts negative values).

With the first press of either a digit key,  $\boxed{0}$  through  $\boxed{9}$ , the decimal point,  $\boxed{.}$ , or the sign button,  $\boxed{\pm}$ , the display will switch into numeric entry mode, with digits being added to the display as they are pressed. To back up a single digit, use the  $\boxed{\leftarrow \times}$  button.

While in numeric entry mode, the ● Pending indicator—just above  $\boxed{\leftarrow}$ —will remain lit. This is to show the numeric value has not yet been set into the instrument. Pressing the  $\boxed{\leftarrow}$  button will accept the currently displayed value. To discard a pending numeric entry without causing the value to be set, press the  $\boxed{\text{Cancel}}$  button.

Pending numeric entries are left-justified on the 6-digit display, while entered settings are right-justified.

*Display ERR* A long-hold ( $\sim 1$  s) of the  $\boxed{\text{Cancel}}$  button will display the list of error codes presently in the error queue. If no errors have occurred since the errors were last cleared (including power-on), then the display `no ERR` will briefly appear. If errors are present, the display will show the error count and error code. For example, if 4 errors have occurred, with the most recent being Illegal Command (21), activation of *Display ERR* will display the following:





$\boxed{\leftarrow}$  and  $\boxed{\rightarrow}$  allow the user to scroll through the error queue. Errors remain in the queue and are only cleared by LERR? queries, the \*CLS command, power cycling of the controller, or the front-panel *Clear ERR* method described below.

Any button other than  $\boxed{\leftarrow}$  and  $\boxed{\rightarrow}$  will exit the Display ERR mode.

*Clear ERR* To clear the entire error queue, a long-hold ( $\sim 1$  s) of the  $\boxed{\leftarrow \times}$  button can be used. The display will read:



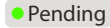







The  Pending indicator will light, indicating that a press of the  button is required to complete the *Clear ERR* operation. All errors will be cleared, and  ERR will turn off. The Status Byte is not cleared.



Any button other than  will cancel the *Clear ERR* operation.

*Factory Reset* To perform a factory reset of the SR542, hold  while powering on the instrument. The instrument will start up in its factory-default configuration. This is identical to sending the \*RST command. See \*RST documentation for a list of settings that are affected by the factory reset.

### 2.2.6 Phase

The  block of the front panel consists only of the  button. For discussion of the  setting, see Section 2.2.2.2.

The  button is used to set the phase = 0° reference from which the phase setpoint is measured. When relative phase is inactive, the  Rel LED is unlit and the displayed  setting represents the commanded phase difference between the source signal and the selected  track, as measured by the shaft encoder.





When  is pressed, the currently displayed  setting is zeroed (similar to pressing the tare button on a scale) and the  Rel indicator illuminates. All subsequent changes to the phase are relative to this new zero.

Pressing  again returns the displayed phase setting to an absolute measurement. See the example provided with the RELP command.

### 2.2.7 Motor

The  button toggles power to the chopper head motor. A long press is required to start the motor, while a short press will bring it to a stop.

At startup, the rotor shaft orientation must first be indexed, and so you may notice several low speed rotations in alternate directions until the index position is found. Following indexing, the motor always spins up to a speed of approximately 5 rev/s in order to survey the installed blade (count the slots of the inner and outer tracks), even if the setpoint frequency requires a speed less than 5 rev/s (including the 0 Hz *shutter mode*). Once the blade has been surveyed, the motor will spin up to the necessary speed to achieve frequency and phase lock. Typically a few seconds are required to achieve phase lock (up to 15 s, depending on the frequency).

When  is pressed to stop the motor, braking current will be applied to bring the chopper wheel to a smooth but rapid halt. The  LED will only shut off after the chopper head has been de-energized, so there will be some delay between the “Stop” button press and the  and  LED indicator updates.

### 2.2.8 Setup

The **SETUP** block consists of buttons that allow the user to save and recall instrument configurations to and from non-volatile memory locations as well as to jump back to the previous configuration.

**Table 2.1:** Configuration settings that are saved (recalled) to (from) non-volatile memory. The factory default values can be recalled from Loc 0.



Setting	Default Value (Loc 0)
Source	Internal Freq
Edge	Rising
Control	Outer
Int Freq	100 Hz
Phase	0.00 deg
Rel Phase Enabled	False
Multiplier, $n$	1
Divisor, $m$	1
VCO FS	100 Hz

#### 2.2.8.1 Save

The  button is used to save the current configuration to a non-volatile memory location. There are 9 available memory locations for user configurations, which can be saved in locations 1, 2, 3,... 9.

Upon pressing , the numeric display will read:



which indicates that the unit is ready to save the current configuration to Location 1. To proceed with the save, press . To change the location, simply press the desired numeric button,  through . The *LOC* will update each time a digit is pressed.

When  is pressed, the control unit will briefly display the following, indicating that it is saving to the selected non-volatile memory location:







### 2.2.8.2 Recall

The  button is used to restore a saved user configuration from a non-volatile memory location. There are 9 available memory locations for user configurations: 1, 2, 3,... 9. Additionally, location 0 is used to recall the default configuration.

If the user wishes to recall memory location 3, for example, press  followed by . The numeric display will read:









which indicates that the unit is ready to overwrite the current configuration with that stored in memory Location 3. To proceed with the recall, press . To change the location, simply press the desired numeric button,  through . To cancel, press .

When  is pressed, the control unit will briefly display the following, indicating that it is loading from the selected non-volatile memory location:



### 2.2.8.3 Back

The  button allows the user to quickly revert the most recent change to the active configuration. For example, if the user has most recently changed the **Int Freq** from 100 Hz to 500 Hz, they can easily jump back to 100 Hz by pressing the Back button (instead of typing  +  +  + , thereby saving several button presses). Back operations have a memory depth of one.

The  button may prove useful when the chopper is used in *shutter mode*, where it would allow the user to easily jump between two different rotational orientations (i.e. the **Phase**) of the chopper blade, to alternately pass and block the beam path. See Section 2.1.3 for further discussion of this mode of operation).

Following a configuration Recall,  reverts all changes made by the Recall. *LOAd* . . . will be briefly displayed.

 does not revert changes to the display mode.

If the Back operation involves changes to the **Source** or **Control**, the changes will be rejected if the motor is running.

## 2.3 Rear Panel Connections and Signals

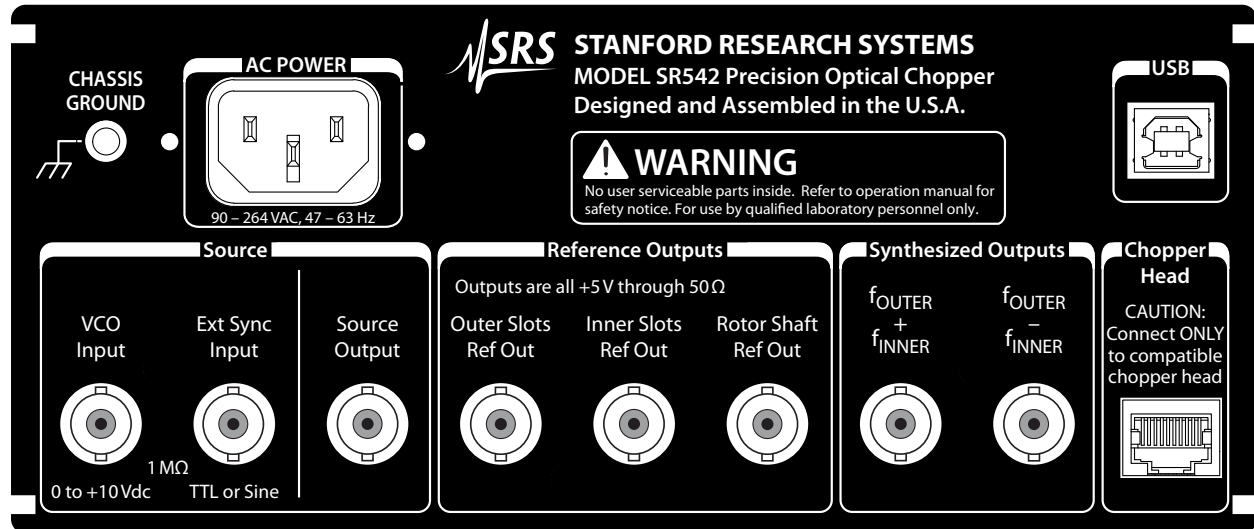

**Figure 2.9:** The SR542 rear panel, with signal inputs and outputs organized into three blocks: Source Inputs and Output, Reference Outputs, and Synthesized Outputs. Also available are a Type-B USB connector for remote communication and RJ50 connector for the 10P10C chopper head cable.

The rear panel of the instrument provides all of the signal input and output BNC connections. Inputs allow external signals to control the frequency and/or phase of the chopper. Reference Outputs can be used to trigger a lock-in amplifier, oscilloscope, box-car averager, photon counter, etc.

In the high state, all outputs provide +5 V through 50 Ω. (If the user connects a 50 Ω termination to an output, only +2.5 V will be present at the output).

Also present on the rear panel are the 3-prong IEC Power Entry Receptacle for the AC power cord, a chassis ground lug, USB Type-B connection for remote communication with the instrument, and an RJ50 connector for the 10P10C chopper head cable. This cable includes lines for motor drive (3 phase AC), chopper head serial communication, shaft encoder and opto-interrupter (inner and outer) signals, power (+5 V) and ground.



### CAUTION

The connection for the chopper head cable is compatible *only* with the provided 10-conductor cable, and cannot be used with a standard 8-wire (RJ45) Ethernet cable.

The BNC connections are organized into three categories:

1. **Source** — inputs and outputs for the reference to which the chopper is phase locked.
2. **Reference Outputs** — TTL logic signals from sensors on the chopper head.
3. **Synthesized Outputs** — TTL square wave signals with frequencies determined by the sum and difference frequencies of the inner and outer tracks. Waveforms are synthesized by the controller.

### 2.3.1 Source Inputs and Output

#### 2.3.1.1 VCO Input

The VCO Input BNC connection accepts a 0 to +10 V<sub>DC</sub> input. When the control unit is configured to use the VCO Input as the source, the DC voltage present at this input is low-pass filtered, digitized, and divided by 10 V to provide a scale factor between 0 and 1. This scale factor, multiplied by the user setting **VCO\_FS** determines the Source frequency.

Mathematically, the DC voltage  $V_{DC}$  determines the source frequency (in Hz) as

$$f_{\text{source}} = \left( \frac{V_{DC}}{10V} \right) \times \text{VCO\_FS}$$

where VCO\_FS is set on the Front Panel using the **VCO\_FS** setting (see Section 2.2.2.2) or using the remote command VCOS.

If **VCO Input** is the selected Source and the resulting  $f_{\text{source}}$  exceeds 23.1 kHz, the **VCO Input** LED will flash. Reduce the **VCO\_FS** setting or the input voltage.

To accommodate an input voltage range of less than 10 V, the **VCO\_FS** gain can be set to large values, up to 999 999 Hz. However, at large gains, the input voltage noise will be amplified and converted to frequency noise, which can make maintaining frequency and phase lock difficult.

#### 2.3.1.2 Ext Sync Input

The Ext Sync Input accepts TTL or sinusoidal inputs. The TTL edge threshold is set to +1 V, and should be driven with a waveform of at least 2 V amplitude. When the sine input is selected via the Sine trigger edge, the input is AC-coupled and is unreliable for frequencies <1 Hz.

#### 2.3.1.3 Source Output

The BNC connection for Source Output provides a +5 V square wave signal at the frequency of the selected **Source**.

### 2.3.2 Reference Outputs

The chopper head has three optical sensors—two slotted interrupters that detect the chopper blade apertures and one encoder that tracks the angular position of the shaft. The +5 V logic signals from these sensors are provided directly to the user at the three BNC Reference Outputs through 50  $\Omega$ .

#### 2.3.2.1 Outer Slots Ref Out

The signal provided at Outer Slots Ref Out is a +5 V logic signal, produced by the opto-interrupter aligned to the outer track of slots.

#### 2.3.2.2 Inner Slots Ref Out

The signal provided at Inner Slots Ref Out is a +5 V logic signal, produced by the opto-interrupter aligned to the inner track of slots. No signal will be present on this output for single-frequency blades.

In order to provide optical access to the slotted opto-interrupter for this signal, dual-frequency blades include an outermost track of apertures, which duplicates the angular positions of the inner track.

#### 2.3.2.3 Rotor Shaft Ref Out

The signal provided at Rotor Shaft Ref Out is a +5 V pulse, produced by the optical encoder affixed to the rear shaft of the chopper head motor. The width of this once-per-revolution pulse depends on the mechanical speed of the rotor shaft, with an output high state that lasts for 1/400<sup>th</sup> of a mechanical revolution.

### 2.3.3 Synthesized Outputs

Two synthesized outputs are provided as +5 V logic signals at the sum and difference frequencies ( $f_{\text{OUTER}} + f_{\text{INNER}}$ ) and ( $f_{\text{OUTER}} - f_{\text{INNER}}$ ). These signals are only present when the chopper is phase locked, and are disabled if either exceeds 23.1 kHz.

#### 2.3.3.1 $f_{\text{OUTER}} + f_{\text{INNER}}$

This output provides a +5 V logic signal at the *sum* of the outer and inner track frequencies. For single-frequency blades, this output will be identical to Outer Slots Ref Out.

#### 2.3.3.2 $f_{\text{OUTER}} - f_{\text{INNER}}$

This output provides a +5 V logic signal at the *difference* of the outer and inner track frequencies. For single-frequency blades, this output will be identical to Outer Slots Ref Out.





---

## 3 Remote Operation

---

This chapter describes operation of the SR542 Precision Optical Chopper via the remote interface.

<b>3.1</b>	<b>List of Commands by Subject</b>	<b>44</b>
<b>3.2</b>	<b>List of Commands by Name</b>	<b>46</b>
<b>3.3</b>	<b>Introduction</b>	<b>48</b>
3.3.1	Interface Configuration	48
3.3.2	Remote Interface Buffers	48
<b>3.4</b>	<b>Commands</b>	<b>48</b>
3.4.1	Command Syntax	48
3.4.2	Notation	49
3.4.3	Examples	49
3.4.4	Configuration Commands	50
3.4.5	Chopper Operation Commands	53
3.4.6	Setup Commands	54
3.4.7	Interface Commands	57
3.4.8	Status Commands	59
<b>3.5</b>	<b>Status Model</b>	<b>62</b>
3.5.1	Status Byte (SB) Register	63
3.5.2	Service Request Enable (SRE) Register	63
3.5.3	Standard Event Status Register (ESR)	64
3.5.4	Standard Event Status Enable (ESE) Register	64
3.5.5	Chopper Status (CHCR/CHEV) Registers	65
3.5.5.1	Chopper Condition Register (CHCR)	65
3.5.5.2	Chopper Positive/Negative Transition (CHPT/CHNT) Registers	65
3.5.5.3	Chopper Event (CHEV) Register	66
3.5.5.4	Chopper Status Enable (CHEN) Register	67
<b>3.6</b>	<b>Error Codes</b>	<b>67</b>
3.6.1	Command Execution Errors	67
3.6.2	Command Parsing Errors	68
3.6.3	Communication Errors	68
3.6.4	Motor Errors	69
3.6.5	Device-Dependent Errors	69
3.6.6	Other Errors	69

### 3.1 List of Commands by Subject

See also: *List of Commands by Name*

The following notation is used in the command descriptions:

Symbol	Definition
$f, g$	Floating-point value
$i, j$	Unsigned integer
$z$	Literal token
(?)	Required for queries; illegal for set commands
<i>var</i>	Parameter always required
{ <i>var</i> }	Required parameter for set commands; illegal for queries
[ <i>var</i> ]	Optional parameter for both set and query forms

#### Configuration

SRCE(?) { $z$ }	Source	50
JINT	Jump to Internal Freq	50
EDGE(?) { $z$ }	External Sync Edge	50
CTRL(?) { $z$ }	Control Target	50
IFRQ(?) { $f$ }	Internal Frequency	50
PHAS(?) { $f$ }	Phase	50
RELP(?) { $z$ }	Relative Phase	51
MULT(?) { $i$ }	Frequency Multiplier	51
DIVR(?) { $i$ }	Frequency Divisor	51
VCOS(?) { $f$ }	VCO Full-Scale Frequency	52
*RST	Reset	52

#### Operation

MOTR(?) { $z$ }	Run/Stop Chopper Motor	53
MFRQ? $z$	Frequency Monitor	53
SLOT? [ $z$ ]	Number of Blade Slots	53

#### Setup

DISP(?) { $z$ }	Display Mode	54
*SAV $i$	Save Configuration	54
*RCL $i$	Recall Configuration	54
BACK	Back to Previous Configuration	55
ALRM(?) { $z$ }	Audible Alarms	55
KCLK(?) { $z$ }	Audible Key Clicks	56

---

**Interface**

---

*IDN? .....	Identify .....	57
TOKN(?) {z} .....	Token Response Mode .....	57
TERM(?) {z} .....	Response Termination .....	57
*OPC(?) .....	Operation Complete .....	58
COPC .....	Cancel Pending *OPC(?) Set/Query .....	58

**Status**

---

*CLS .....	Clear Status .....	59
LERR? .....	Last Error .....	59
*STB? [i] .....	Status Byte .....	59
*SRE(?) [i,] {j} .....	Service Request Enable .....	60
*ESR? [i] .....	Event Status Register .....	60
*ESE(?) [i,] {j} .....	Event Status Enable .....	60
CHCR? [i] .....	Chopper Condition .....	61
CHPT? [i,] {j} .....	Chopper Condition Positive Transition .....	61
CHNT? [i,] {j} .....	Chopper Condition Negative Transition .....	61
CHEV? [i] .....	Chopper Event .....	61
CHEN(?) [i,] {j} .....	Chopper Event Enable .....	61

## 3.2 List of Commands by Name

See also: *List of Commands by Subject*

**\***

---

*CLS .....	Clear Status .....	59
*ESE(?) [i,] {j} .....	Event Status Enable .....	60
*ESR? [i] .....	Event Status Register .....	60
*IDN? .....	Identify .....	57
*OPC(?) .....	Operation Complete .....	58
*RCL i .....	Recall Configuration .....	54
*RST .....	Reset .....	52
*SAV i .....	Save Configuration .....	54
*SRE(?) [i,] {j} .....	Service Request Enable .....	60
*STB? [i] .....	Status Byte .....	59

**A**

---

ALRM(?) {z} .....	Audible Alarms .....	55
-------------------	----------------------	----

**B**

---

BACK .....	Back to Previous Configuration .....	55
------------	--------------------------------------	----

**C**

---

CHCR? [i] .....	Chopper Condition .....	61
CHEN(?) [i,] {j} .....	Chopper Event Enable .....	61
CHEV? [i] .....	Chopper Event .....	61
CHNT? [i,] {j} .....	Chopper Condition Negative Transition .....	61
CHPT? [i,] {j} .....	Chopper Condition Positive Transition .....	61
COPC .....	Cancel Pending *OPC(?) Set/Query .....	58
CTRL(?) {z} .....	Control Target .....	50

**D**

---

DISP(?) {z} .....	Display Mode .....	54
DIVR(?) {i} .....	Frequency Divisor .....	51

**E**

---

EDGE(?) {z} .....	External Sync Edge .....	50
-------------------	--------------------------	----

**I**

---

 IFRQ(?) {f} ..... Internal Frequency ..... 50
**J**

---

 JINT ..... Jump to Internal Freq ..... 50
**K**

---

 KCLK(?) {z} ..... Audible Key Clicks ..... 56
**L**

---

 LERR? ..... Last Error ..... 59
**M**

---

 MFRQ? z ..... Frequency Monitor ..... 53

MOTR(?) {z} ..... Run/Stop Chopper Motor ..... 53

MULT(?) {i} ..... Frequency Multiplier ..... 51

**P**

---

 PHAS(?) {f} ..... Phase ..... 50
**R**

---

 RELP(?) {z} ..... Relative Phase ..... 51
**S**

---

 SLOT? [z] ..... Number of Blade Slots ..... 53

SRCE(?) {z} ..... Source ..... 50

**T**

---

 TERM(?) {z} ..... Response Termination ..... 57

TOKN(?) {z} ..... Token Response Mode ..... 57

**V**

---

 VCOS(?) {f} ..... VCO Full-Scale Frequency ..... 52

### 3.3 Introduction

Remote operation of the SR542 is through a simple command language documented in this chapter. Both set and query forms of most commands are supported, allowing the user complete control of the SR542 from a remote computer via a USB interface.

Where applicable, the corresponding front-panel interface to each command is also indicated. Most instrument settings are retained in non-volatile memory. Upon power-on, these settings are restored to their values from before the power was turned off. Where appropriate, the default value for parameters is listed in **boldface** in the command descriptions. These default values are restored by a factory reset (\*RST), or when recalling memory location 0.

#### 3.3.1 Interface Configuration

The USB interface is implemented as a serial port emulator, with fixed rate of 115,200 baud, 8 data bits, no parity or flow control.

The front-panel indicator  indicates remote interface activity (both incoming and outgoing messages).

#### 3.3.2 Remote Interface Buffers

The SR542 stores incoming bytes received via the USB interface in a 256-byte input buffer. Characters accumulate in the input buffer until a command terminator (<CR> or <LF>) is received, at which point the message is parsed and the corresponding command(s) is (are) executed. Query responses from the SR542 are buffered into a 256-byte output buffer.

If the input buffer overflows, then an INPUT BUFFER OVERRUN error is added to the error queue and the INP bit is set in the ESR status register. All data in the input buffer are cleared.

### 3.4 Commands

This section provides syntax and descriptions for all remote commands.

#### 3.4.1 Command Syntax

The four letter mnemonic (shown in CAPS) in each command sequence specifies the command. Depending on the command, the mnemonic can be followed by zero to three parameters.

Commands may take either *set* or *query* form, depending on whether the “?” character follows the mnemonic. *Set only* commands are listed without the “?”, *query only* commands show the “?” after the mnemonic, and *optionally query* commands are marked with a “(?)”.

Parameters shown in { } and [ ] are not always required. Parameters in { } are required to set a value, and should be omitted for queries. Parameters in [ ] are optional in both set and query commands. Parameters listed without surrounding characters are always required.

Do *not* send ( ) or { } or [ ] as part of the command.

Multiple parameters are separated by commas. Multiple commands may be sent on one command line by separating them with semicolons (;) so long as the input buffer does not overflow. Commands are terminated by either <CR> or <LF> characters. Null commands and whitespaces are ignored. Execution of the command does not begin until the command terminator is received.

tokens *Token* parameters (generically shown as *z* in the command descriptions) can be specified either as a keyword or as an integer value. Command descriptions list the valid keyword options, with each keyword followed by its corresponding integer value. For example, to set the frequency source to Internal Freq, the following two commands are equivalent:

SRCE INT      *—or—*      SRCE 0

For queries that return token values, the return format (keyword or integer) is specified with the TOKN command.

### 3.4.2 Notation

The following notation is used in the command descriptions:

Symbol	Definition
<i>f, g</i>	Floating-point value
<i>i, j</i>	Unsigned integer
<i>z</i>	Literal token
(?)	Required for queries; illegal for set commands
<i>var</i>	Parameter always required
{ <i>var</i> }	Required parameter for set commands; illegal for queries
[ <i>var</i> ]	Optional parameter for both set and query forms

### 3.4.3 Examples

Each command is provided with a simple example illustrating its usage. In these examples, all data sent by the host computer to the SR542 are set as *straight teletype font*, while responses received by the host computer from the SR542 are set as *slanted teletype font*.

The usage examples provided below for each command vary with respect to set/query, optional parameters, and token formats. They are not exhaustive, and are intended to provide a convenient starting point for user programming.

### 3.4.4 Configuration Commands

---

SRCE(?) {z}	<p><b>Source</b></p> <p>Set (query) the frequency source which serves as the reference {to z = (INT 0, VCO 1, LINE 2, EXT 3)}.</p> <p><i>Example:</i> &gt;SRCE EXT &gt;SRCE? 3</p>
<hr/>	
JINT	<p><b>Jump to Internal Freq</b></p> <p>Save the current Source frequency as Int Freq and change the Source to Internal Freq.</p> <p>Identical to a long press of the  button.</p> <p><i>Example:</i> &gt;JINT</p>
<hr/>	
EDGE(?) {z}	<p><b>External Sync Edge</b></p> <p>Set (query) the external edge used to trigger the Source PLL {to z = (RISE 0, FALL 1, SINE 2)}.</p> <p><i>Example:</i> &gt;EDGE? 0</p>
<hr/>	
CTRL(?) {z}	<p><b>Control Target</b></p> <p>Set (query) the track which is to be phase locked to the Source {to z = (SHAFT 0, INNER 1, OUTER 2)}.</p> <p><i>Example:</i> &gt;CTRL? OUTER</p>
<hr/>	
IFRQ(?) {f}	<p><b>Internal Frequency</b></p> <p>Set (query) the Internal Frequency {to {f}}, in Hz.</p> <p><i>Example:</i> &gt;IFRQ 255.17</p>
<hr/>	
PHAS(?) {f}	<p><b>Phase</b></p> <p>Set (query) the phase of the selected Control target, measured in optical degrees. For discussion of valid Phase settings, see Section 2.2.2.2.</p> <p><i>Example:</i> &gt;PHAS 90.0</p>

---



---

**3.4.4 Configuration Commands** (continued)
REL $P$ (?) {z}**Relative Phase**

Set (query) the chopper phase display as a relative measurement {to  $z = (\text{OFF } 0, \text{ON } 1)$ }. When relative phase is switched from OFF to ON, the current phase is subtracted from the displayed value, such that the displayed value jumps to  $0^\circ$ . Any changes to the phase while relative phase remains ON are now displayed relative to this new zero. Switching relative phase from ON to OFF will add back the original phase offset to the currently displayed value of Phase.

The REL $P$  command is similar to pressing , though the set command requires {z}, and does not automatically toggle the Relative Phase state.

*Example:*  $\gg$ PHAS?  
           90.0000  
 $\gg$ REL $P$  ON  
 $\gg$ PHAS?  
           0.0000  
 $\gg$ PHAS 15.6  
 $\gg$ REL $P$  OFF  
 $\gg$ PHAS?  
           105.6000

---

MULT(?) {i}
**Frequency Multiplier**

Set (query) the integer multiplier  $n$  of the frequency source {to  $i = (1, 2, 3, \dots, 200)$ }.

*Example:*  $\gg$ MULT 2

---

DIVR(?) {i}
**Frequency Divisor**

Set (query) the integer divisor  $m$  of the frequency source {to  $i = (1, 2, 3, \dots, 200)$ }.

*Example:*  $\gg$ DIVR?  
           3

---

**3.4.4 Configuration Commands** (continued)

---

VCOS(?) {f}

**VCO Full-Scale Frequency**

Set (query) the full-scale frequency (in Hz) corresponding to a VCO Input voltage of +10 V.

See Section 2.3.1.1 for further discussion the VCO Input.

*Example:* `»VCOS 5000.0`

---

\*RST

**Reset**

Reset the SR542 to its default configuration. Sending the \*RST command is equivalent to sending the following:



```
»MOTR OFF
»SRCE INT
»EDGE RISE
»CTRL OUTER
»DISP INT
»IFRQ 100.00
»PHAS 0.0
»MULT 1
»DIVR 1
»VCOS 100.00
»RELP OFF
»KCLK ON
»ALRM ON
```

A factory reset can also be performed by holding 0 while powering on the instrument.

### 3.4.5 Chopper Operation Commands

MOTR(?) {z}

#### Run/Stop Chopper Motor

Set (query) the chopper motor state to {to z = (OFF 0, ON 1)}. MOTR ON is equivalent to pressing  when the motor is stopped. MOTR OFF is equivalent to pressing  when the motor is running. Braking current is applied to bring the chopper blade to a stop (i.e. power to the chopper head is not immediately turned off).

Example: `>>MOTR ON`  
`>>MOTR?`  
*ON*

MFRQ? z

#### Frequency Monitor

Query the monitored frequency of {z = (OUTER 0, INNER 1, SHAFT 2, SRCE 3, SUM 4, DIFF 5, CTRL 6)}.

Because Sum and Difference Reference Outputs are synthesized from the Source Clock, queries of SUM or DIFF will return the *target* synthesized frequency  $(n_{\text{OUTER}} \pm n_{\text{INNER}}) \times f_{\text{ref}}$  and not the instantaneous *measured* frequency given by  $(n_{\text{OUTER}} \pm n_{\text{INNER}}) \times f_{\text{shaft}}$ .

Similarly, a query of the CTRL frequency returns the *target* value of the control frequency  $(f_{\text{source}} \times \frac{n}{m})$ , and not the measured value of the selected control track.

Example: `>>MFRQ? OUTER`  
*3500.0171*

SLOT? [z]

#### Number of Blade Slots

Query the number of slots for the installed chopper blade [with z = (OUTER 0, INNER 1)]. If no optional parameter is specified, returns (i, j), where i is the number of slots detected on the inner track, and j is the number of slots detected on the outer track. For single-track blades, i = 0.

If SLOT? is queried before running the chopper motor, the returned slot count may be inaccurate.

Example: `>>SLOT?`  
*10, 100*  
`>>SLOT? INNER`  
*10*

### 3.4.6 Setup Commands

DISP(?) {z}

#### Display Mode

Set (query) the display mode {to z = (**OUTER** 0, INNER 1, SHAFT 2, SRCE 3, INT 4, PHASE 5, MULTN 6, DIVM 7, VCOFS 8)}.

The query form can also return z = DISPERR 9 or CLRERR 10. These special display modes are accessible only through front panel operations, via a long hold of  and , respectively.

*Example:* `>>DISP?`  
`SRCE`

\*SAV *i*

#### Save Configuration

Save the current configuration in memory location  $i = (1, 2, \dots, 9)$ . User configurations cannot be saved to memory location 0.

For a list of parameters that are saved, see Table 2.1.

*Example:* `>>*SAV 1`

\*RCL *i*

#### Recall Configuration

Recall the saved configuration from memory location  $i = (0, 1, \dots, 9)$ . Recalling from memory location 0 restores the factory default configuration.

For a list of parameters that are recalled (and the default values recalled from location 0), see Table 2.1.

*Example:* `>>*RCL 4`

### 3.4.6 Setup Commands (continued)

#### BACK

#### Back to Previous Configuration

This command is identical to pressing , and can be used to revert the most recently-updated setting. Repeated BACK commands will toggle the setting between two values.

Example: `>BACK`

Settings that revert with the BACK command or  button include:

- Source
- Edge
- Control Track
- Internal Frequency
- Phase
- Multiplier  $n$
- Divisor  $m$
- VCO FS
- Relative Phase Enable
- *Jump to Int.* If a Jump to Int was just performed, Back will jump back to the previous Source and revert the Int Freq to the previous value.
- Recall. All settings modified by the recent Recall will be reverted. *L P d . . .* will be briefly displayed.

It is possible that a BACK operation cannot be performed currently. For example, if the most recent settings change was the Control track, BACK will be rejected if the motor is running. The front panel will briefly display *P r o h i b* in this case.

#### ALRM(?) {z}

#### Audible Alarms

Set (query) the audible alarms {to  $z = \{\text{OFF } 0, \text{ON } 1\}$ }.

The alarm setting can also be accessed and modified from the front panel following a long-hold (~1 s) of the rotary knob. See *Audio Settings*.

Example: `>ALRM 1`

**3.4.6 Setup Commands** (continued)

---

KCLK(?) {z}

**Audible Key Clicks**

Set (query) the audible key clicks {to z = (OFF 0, ON 1)}.

The key click setting can also be accessed and modified from the front panel following a long-hold (~1 s) of the rotary knob. See *Audio Settings*.

Example: »KCLK?  
1

---

### 3.4.7 Interface Commands

---

\*IDN?

**Identify**

Query the SR542 identification string.

The response is formatted as:

Stanford\_Research\_Systems,SR542,s/n\*\*\*\*\*,ver#.#.#

where \*\*\*\*\* is the 8-digit serial number, and #.#.# is the firmware revision level.

*Example:* »\*IDN?  
Stanford\_Research\_Systems,SR542,s/n00000001,ver1.0.0

---

TOKEN(?) {z}

**Token Response Mode**

Set (query) the token response mode {to z = (OFF 0, ON 1)}.

Token response mode controls the formatting of response messages generated by the SR542 to remote queries of token-type values. When token response mode is turned off by **TOKEN OFF**, the SR542 responds with the numeric version of the token quantity. When turned on by **TOKEN ON**, the text version is returned.

The token response mode is unmodified by the \*RST command, and is always restored to OFF (0) at power-on.

*Example:* »TOKEN?  
ON

---

TERM(?) {z}

**Response Termination**

Set (query) the response termination {to z = (NONE 0, CR 1, LF 2, CRLF 3, LFCR 4)}.

Response messages generated by the SR542 will be terminated by the 0-, 1- or 2-character termination sequence specified by TERM.

The response termination is unmodified by the \*RST command, and is always restored to CRLF (3) at power-on.

*Example:* »TERM LF

---

---

**3.4.7 Interface Commands** (continued)
 

---

**\*OPC(?)****Operation Complete**

The set form, \*OPC, will set the OPC bit in the Standard Event Status register; the query form, \*OPC?, will return the value 1.

The \*OPC? query response will not be sent by the SR542 until all preceding commands have been executed and completed. Equivalently, the \*OPC command will not set the OPC bit until all preceding commands have been executed and completed.

*Example:* »\*OPC?  
1

Most of the SR542 remote commands are processed and executed without delay, so the command sequence <RCMD>; \*OPC? will return 1 immediately for a general remote command <RCMD>. The primary exception to this is following a motor shutdown command, MOTR OFF, which initiates a deceleration of the motor. The deceleration can last several seconds depending on the initial speed of the motor. Therefore, the following command sequence can be used to ensure the motor has come to a complete stop:

*Example:* »MOTR OFF; \*OPC?  
1

**COPC****Cancel Pending \*OPC(?) Set/Query**

Cancels a currently pending operation complete set or query (\*OPC(?)).



---

### 3.4.8 Status Commands

---

**\*CLS****Clear Status**

Immediately clear all event status registers and the error queue.

*Example:* »\*CLS

---

**LERR?****Last Error**

Query the last recorded error from the 32-element error queue. Errors are read out in a last-in-first-out manner. A response of 0 indicates no errors have occurred since the last LERR? query (or the last *Clear ERR* operation or \*CLS command). See Section 3.6 for a list of possible error codes and their meanings.

*Example:* »LERR?  
25

---

**\*STB? [i]****Status Byte**

Query the Status Byte register, or individual bit [i]. If no bit parameter is included, the response is the binary-weighted sum of all set bits in the Status Byte register.

Bits in the Status Byte are updated in real time and bits are not cleared when read. Power cycling or \*CLS will clear the Status Byte.

See also Section 3.5 on the Status Model.

*Example:* »\*STB?  
32

---

---

**3.4.8 Status Commands** (continued)
\*SRE(?) [*i*] {*j*}**Service Request Enable**

Set (query) the Service Request Enable register for the Status Byte register. At least one integer parameter is required, and a second integer parameter is optional. When setting, if only a single parameter {*j*} is sent, {*j*} is the binary-weighted sum of the bits to be enabled. For example, to enable bits 5 and 7, {*j*} is set to  $32 + 128 = 160$ .

*Example:* `>>*SRE 160`

If both [*i*] and {*j*} are sent, then [*i*] represents the bit number (0 through 7), and {*j*} can be either 0 or 1. Bits  $\neq i$  are unaffected.

*Example:* `>>*SRE 5, 0`

A query with no included bit parameter returns the binary-weighted sum of the enabled bits. A query with an included bit parameter returns the value of that bit.

*Example:* `>>*SRE?`  
           128  
`>>*SRE? 7`  
           1

See also Section 3.5 on the Status Model.

---

\*ESR? [*i*]**Event Status Register**

Query the Standard Event Status Register [bit *i*].

Upon executing \*ESR?, the returned bit(s) of the ESR register are cleared.

*Example:* `>>*ESR?`  
           64

---

\*ESE(?) [*i*] {*j*}**Event Status Enable**

Set (query) the Standard Event Status Enable Register [bit *i*] {to *j*}.

*Example:* `>>*ESE 6, 1`  
`>>*ESE?`  
           64

---

**3.4.8 Status Commands** (continued)

---

CHCR? [i]	<p><b>Chopper Condition</b></p> <p>Query the Chopper Condition Register [bit i].</p> <p><i>Example:</i> &gt;CHCR? 0 1</p>
<hr/>	
CHPT? [i,] {j}	<p><b>Chopper Condition Positive Transition</b></p> <p>Set (query) the Chopper Condition Positive Transition register [bit i] {to j}.</p> <p><i>Example:</i> &gt;CHPT 8</p>
<hr/>	
CHNT? [i,] {j}	<p><b>Chopper Condition Negative Transition</b></p> <p>Set (query) the Chopper Condition Negative Transition register [bit i] {to j}.</p> <p><i>Example:</i> &gt;CHNT 2, 1</p>
<hr/>	
CHEV? [i]	<p><b>Chopper Event</b></p> <p>Query the Chopper Event Register [bit i].</p> <p>Upon executing a CHEV? query, the returned bit(s) of the CHEV register are cleared.</p> <p><i>Example:</i> &gt;CHEV? 5 &gt;CHEV? 0</p>
<hr/>	
CHEN(?) [i,] {j}	<p><b>Chopper Event Enable</b></p> <p>Set (query) the Chopper Event Status Enable Register [bit i] {to j}.</p> <p><i>Example:</i> &gt;CHEN 3, 1</p>

---

### 3.5 Status Model

The SR542 status registers follow the hierarchical IEEE–488.2 format. A block diagram of the status register array is given in Figure 3.1.

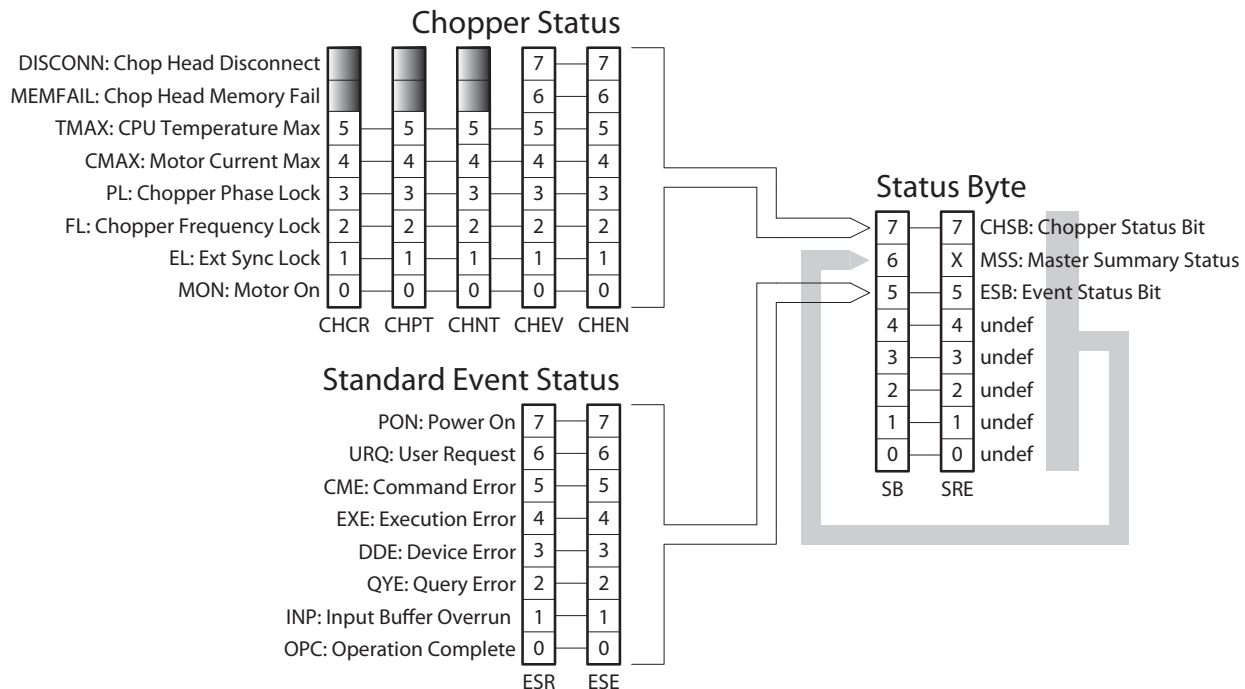

**Figure 3.1:** Status Model for the SR542 Precision Optical Chopper.

There are five categories of registers in the status model of the SR542:

**Condition Registers :** These read-only registers correspond to the real-time condition of some underlying physical property being monitored. Queries return the latest value of the property, and have no further side effects. Condition register names end with CR.

**Transition Selection Registers :** These read/write registers define specific transition events (positive:  $0 \rightarrow 1$ , or negative:  $1 \rightarrow 0$ ). The event is then defined by the selected transition in the value of the underlying condition register. Transition register names end with PT or NT for positive and negative transitions, respectively.

**Event Registers :** These read-only registers record the occurrence of defined events within the SR542. If the event occurs, the corresponding bit is set to 1. Upon querying an event register, any set bits within it are cleared. These are sometimes known as “sticky bits,” since once set, a bit can only be cleared by reading its value, or by issuing the global \*CLS Clear Status command. Event register names end with SR or EV.

**Enable Registers :** These read/write registers define a bitwise mask for their corresponding event register. If any bit position is set in an event register while the same bit position is also set in the enable register, then the corresponding summary bit message is set in the Status Byte. Enable register names end with SE or EN. The SRE register (Service Request Enable) also acts as an enable register.

**Status Byte :** This read-only register represents the top of the status model, and is populated with summary bits. Enabled bits within the Status Byte generate the Master Summary Status bit within the Status Byte register.

### 3.5.1 Status Byte (SB) Register

The Status Byte is the top-level summary of the SR542 status model. When enabled by the Service Request Enable register, a bit set in the Status Byte causes the MSS (Master Summary Status) bit to be set.

Weight	Bit	Flag
1	0	undef (0)
2	1	undef (0)
4	2	undef (0)
8	3	undef (0)
16	4	undef (0)
32	5	ESB
64	6	MSS
128	7	CHSB

**ESB :** Event Status Bit. Indicates whether one or more of the enabled events in the Standard Event Status Register is true.

**MSS :** Master Summary Status. Indicates whether one or more of the enabled status messages in the Status Byte register is true.

**CHSB :** Chopper Status Bit. Indicates whether one or more of the enabled events in the Chopper Event Status Register is true.

This register is read with the `*STB?` query. The bits of the Status Byte are not cleared by the `*STB?` query. These bits are only cleared by reading the underlying event registers, or by clearing the corresponding enable registers.

### 3.5.2 Service Request Enable (SRE) Register

Each bit in the SRE corresponds one-to-one with a bit in the SB register, and acts as a bitwise AND of the SB flags to generate MSS. Bit 6 of the SRE is undefined—setting it has no effect, and reading it always returns 0. This register is set and queried with the `*SRE(?)` command.

At power-on, this register is cleared.

### 3.5.3 Standard Event Status Register (ESR)

The Standard Event Status Register consists of 8 event flags. These event flags are all “sticky bits” that are set by the corresponding events, and cleared only by reading the byte with the \*ESR? query or with the \*CLS command. Reading a single bit (with the \*ESR? *i* query) clears only bit *i*.

Weight	Bit	Flag
1	0	OPC
2	1	INP
4	2	QYE
8	3	DDE
16	4	EXE
32	5	CME
64	6	URQ
128	7	PON

**OPC** : Operation Complete. Set by the \*OPC command.

**INP** : Input Buffer Overrun. Indicates overflow of the 256-byte input buffer that handles serial communications. The buffer is cleared on an overrun, causing loss of data. Dropped commands will need to be re-sent.

**QYE** : Query Error. Indicates data in the output buffer has been lost.

**DDE** : Device-Dependent Error. Indicates an issue with SR542 configuration or control signals.

**EXE** : Execution Error. Indicates an error in a command that was successfully parsed. Out-of-range parameters are an example.

**CME** : Command Error. Indicates a command parser-detected error.

**URQ** : User Request. Indicates that a front-panel button was pressed.

**PON** : Power On. Indicates that an off-to-on transition has occurred.

### 3.5.4 Standard Event Status Enable (ESE) Register

The ESE acts as a bitwise AND with the ESR register to produce the single-bit ESB message in the Status Byte Register (SB). The register can be set and queried with the \*ESE(?) command.

At power-on, this register is cleared.

### 3.5.5 Chopper Status (CHCR/CHEV) Registers

The Chopper status is monitored by a real-time condition register (CHCR), a pair of transition selection registers (CHPT and CHNT), and the latching event register (CHEV).

#### 3.5.5.1 Chopper Condition Register (CHCR)

The Chopper Condition Register consists of 5 condition flags that reflect the real-time condition of the SR542. Reading the CHCR has no effect on any values.

Weight	Bit	Flag
1	0	MON
2	1	EL
4	2	FL
8	3	PL
16	4	CMAX
32	5	TMAX

**MON** : Motor On. Power to the chopper head is enabled.

**EL** : External Lock. The internal clock is phase-locked to the Ext Sync input or AC Line (depending on Source selection).

**FL** : Frequency Lock. The chopper is frequency-locked to the configured Source reference,  $(f_{\text{source}} \times \frac{n}{m})$ .

**PL** : Phase Lock. The chopper is phase-locked to the configured Source reference,  $(f_{\text{source}} \times \frac{n}{m})$ .

**CMAX** : Current Max. Current to the chopper head exceeds the rated maximum. If running the chopper motor at high speeds, a CMAX condition could be the cause of an unstable phase lock. Try running at a lower speed.

**TMAX** : Temperature Max. The temperature of the CPU exceeds the rated maximum. If running, the chopper head will be shut down immediately. Motor restart is prohibited until the CPU has cooled sufficiently.

#### 3.5.5.2 Chopper Positive/Negative Transition (CHPT/CHNT) Registers

These two 8-bit wide registers control the mapping of transitions in the CHCR to event flags in the CHEV register. For any particular event, if the corresponding bit is set in CHPT, then a 0→1 transition in the CHCR causes the bit to be set in the CHEV. Likewise, if a bit is set in CHNT, then a 1→0 transition in the CHCR causes the bit to be set in the CHEV.

All combinations of CHPT and CHNT settings are valid. At power-on, both CHPT and CHNT are cleared.

### 3.5.5.3 Chopper Event (CHEV) Register

This 8-bit wide register monitors selected events in the CHCR, based on transitions selected in CHPT and CHNT. When the selected transition(s) occur, the corresponding bit is set. Reading the register clears it (reading a single bit clears only that bit). This register is also cleared by the \*CLS command.

In addition to monitored events from the CHCR, two discrete events—a chopper head memory failure or sudden disconnect—are directly defined in CHEV without a corresponding real-time condition bit in the CHCR:

Weight	Bit	Flag
64	6	Chopper Head Memory Fail
128	7	Chopper Head Disconnect

On each motor startup, the control unit reads calibration and identification information from the chopper head. If this memory access fails, bit 6 of the CHEV register will be set.

If the chopper head cable is not properly connected, bit 7 of the CHEV register will be set. The chopper head cable connectivity is checked at motor startup and monitored continuously during motor operation. Connectivity is not monitored when the motor is off.

An example use case of CHNT and CHEV is shown in Figure 3.2. Before the start of the example, the command CHNT 8 is sent to latch negative (1→0) transitions of the CHCR PL (Phase Locked) bit into the CHEV register. Note that periodic monitoring of the CHCR real-time register may miss a temporary loss-of-lock depending on the timing of the CHCR? query.

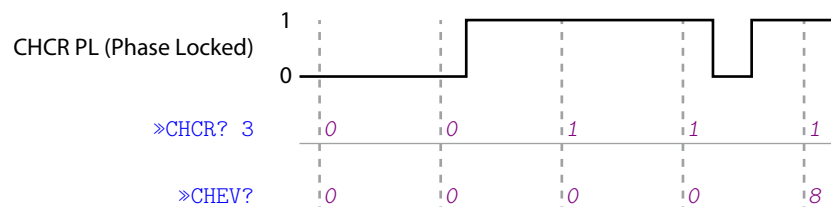

**Figure 3.2:** Phase Lock status (0 or 1) of the chopper head versus time. Negative (1→0) transitions of the CHCR PL status bit can be latched into the CHEV register by commanding CHNT 8. Query results for CHCR? 3 and CHEV? are shown as numeric responses at the indicated timing.







### 3.5.5.4 Chopper Status Enable (CHEN) Register

This is an 8-bit wide register that masks the CHEV register. The logical OR of the bitwise AND of CHEV and CHEN produces the CHSB message in the Status Byte register (SB).

## 3.6 Error Codes

The SR542 contains an error buffer that can store up to 32 error codes associated with errors encountered during command parsing, command execution, or motor operation. The error LED will illuminate () when an error occurs for any reason. The errors in the buffer may be read one-by-one by executing successive LERR? queries, after which they are removed from the buffer.

Errors in the buffer can also be accessed via the front panel by a long-hold (~1 s) of the  button. Viewing error codes from the front panel does not remove them from the error buffer. See discussion of *Display ERR*.

The error LED will go off () when all errors have been retrieved by LERR? or the error queue has been cleared by a \*CLS command. Alternatively, all errors stored in the the error queue can be cleared via the front panel by a long-hold (~1 s) of the , followed by  to confirm. See the discussion of *Clear ERR*.

The meaning of each of the error codes is defined below.

### 3.6.1 Command Execution Errors

Execution errors occur when the SR542 successfully parsed a command but fails to execute it, usually because of invalid parameters.

- 1 : Illegal value. A parameter was out of range.
- 2 : Wrong token. The received token is not valid for the given command.
- 3 : Invalid bit. The received bit number is not valid for the given command.
- 13 : Recall failed. The recall of instrument settings from nonvolatile storage failed. If the recall failed at instrument startup, the instrument reverts to its default configuration. If the recall fails during a user recall, no changes are made to the current configuration.
- 14 : Save failed.
- 15 : Invalid memory location.
- 19 : Internal error.

### 3.6.2 Command Parsing Errors

Parsing errors indicate that the syntax of the received command string is invalid.

- 21 : Illegal Command. The received command string was fewer than four characters, or contained invalid characters (the four-character command string can consist only of alphabetic characters or "\*").
- 22 : Undefined Command. The received command string does not match a known 4-letter command.
- 23 : Illegal Query. The received command is only valid in set form ("?" is not allowed).
- 24 : Illegal Set. The received command is only valid in query form ("?" is required).
- 25 : Missing Parameters. The parser expected more parameters than it received.
- 26 : Extra Parameters. The parser received more parameters than it expected.
- 27 : Null Parameter. The parser received no value for the expected parameter.
- 28 : Parameter Buffer Overflow. The buffer that stores the characters of a token parameter has overflowed. All valid token strings are shorter than this buffer. Please check the token string.
- 29 : Bad Float. Conversion of a parameter string to floating-point variable failed.
- 30 : Bad Integer. Conversion of a parameter string to integer variable failed.
- 31 : Bad Token Integer. Conversion of a token parameter string to integer variable failed.
- 32 : Bad Token Value. The received token value was less than 0 or greater than 255.
- 33 : Unknown Token. The received token did not match any known tokens.
- 39 : Internal Error.

### 3.6.3 Communication Errors

- 41 : Input Buffer Overrun. The input buffer of the remote interface overflowed. All data in the input buffer will be flushed.
- 42 : Output Buffer Overrun. The output buffer of the remote interface overflowed. All data in the output buffer will be flushed.

### 3.6.4 Motor Errors

- 51 : Chopper head memory fail. On each motor startup, the SR542 attempts to read calibration and identification information from the chopper head. Error 51 indicates that this read operation has failed. Motor startup cannot proceed. Please contact SRS to arrange for the return of the chopper head for service.
- 52 : Chopper head disconnected. The chopper head has become disconnected from the control unit. Please check the chopper head cable.

### 3.6.5 Device-Dependent Errors

- 71 : Maximum frequency exceeded. The chopper configuration has resulted in an internal clock frequency that exceeds the maximum (23.1 kHz). The Source Clock and Shaft Reference Clock cannot exceed 23.1 kHz.  
  
The user should adjust the Source frequency, modify the *Multiplier* (reduce *n* or increase *m*), or change the *Control* track to a track with higher slot count.
- 72 : No inner slots detected. This can occur if the installed blade has no apertures for the inner track. If using a single-frequency chopper blade, change the *Control* track to Outer or Shaft. Otherwise, check to make sure the opto-interrupter for the inner track, positioned on the outer-most diameter of the chopper blade, is not blocked.
- 73 : No outer slots detected. Check to make sure the opto-interrupter for the outer track, which is positioned slightly higher, is not blocked.
- 74 : Motor lost. If this error occurs during startup, it indicates that the shaft encoder index was not found. Check to make sure the chopper blade can freely rotate. If this error consistently occurs during steady motor operation, ensure the chopper head cable shield is properly grounded (see Section 5.1). If the issue persists, it is possible that the shaft encoder or chopper head cable have been compromised. Return the chopper head and cable for service.
- 75 : Maximum operating temperature. If the maximum operating temperature is exceeded, the controller turns off the motor.

### 3.6.6 Other Errors

- 254 : Too many errors. The error buffer is full and no longer able to store additional errors. Either read out the errors with repeated LERR? queries, or clear the error queue with a \*CLS command. The error buffer can also be cleared from the front panel (see discussion of *Clear ERR*).



---

## 4 Applications

---

This chapter discusses common experimental applications of the SR542 Precision Optical Chopper.

4.1 Single Beam Experiment . . . . .	72
4.2 Dual Beam Experiment . . . . .	73
4.3 Detection at Sum and Difference Frequencies . . . . .	74

## 4.1 Single Beam Experiment

This is the simplest optical chopping experiment. In this application, a single optical beam is chopped by either the Inner or Outer track of slots, and the reference output from the corresponding Inner/Outer Slots Ref Out BNC connection is used as the Ref In to a lock-in amplifier.

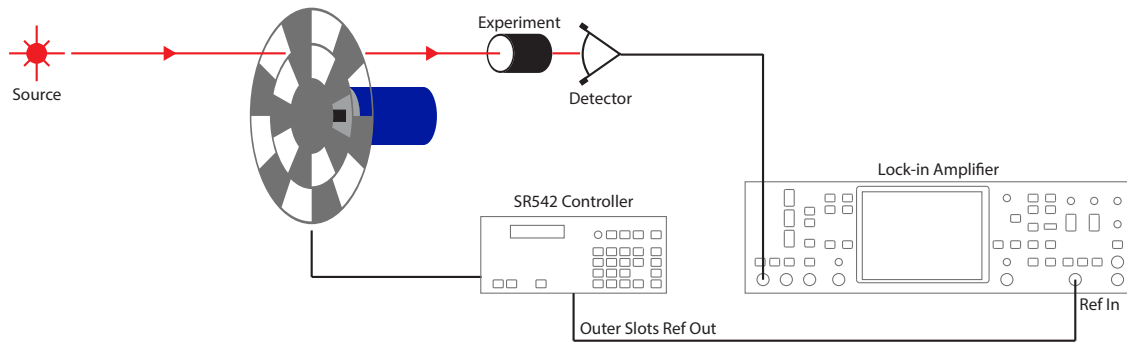

Figure 4.1: Single Beam Experiment

## 4.2 Dual Beam Experiment

In a single beam experiment, fluctuations in the light source output can appear as changes in the experimental signal. To eliminate source fluctuations, a dual beam experiment can be used.

The use of two modulated optical beams, derived from the same source, enables a ratiometric measurement that can be used to control for fluctuations in the light source output. The SR542 dual-frequency blades are made for just this purpose. One of the beams passes through the experiment, while the other beam, a reference beam, passes through a control arm. The beams are recombined and sent to the same detector.

Two lock-ins are used to detect the two signals which are at different frequencies. In the setup shown in Figure 4.2, the signal at  $f_{\text{INNER}}$  corresponds to the control arm; the signal at  $f_{\text{OUTER}}$  is the response from the experimental arm. If the detected signal in the experimental arm is ratioed to the detected signal from the control arm, then effects due to changing source intensity and detector efficiency are removed. To ratio the experimental signal to the control signal, the demodulated signal from the control arm is output from lock-in #1. This DC signal is sent to an Aux Input of lock-in #2.

Also note that each beam passes through one beam splitter, reflects off one beam splitter, and reflects off one mirror, so that effects due to these components are canceled to first order in the ratioed measurement.

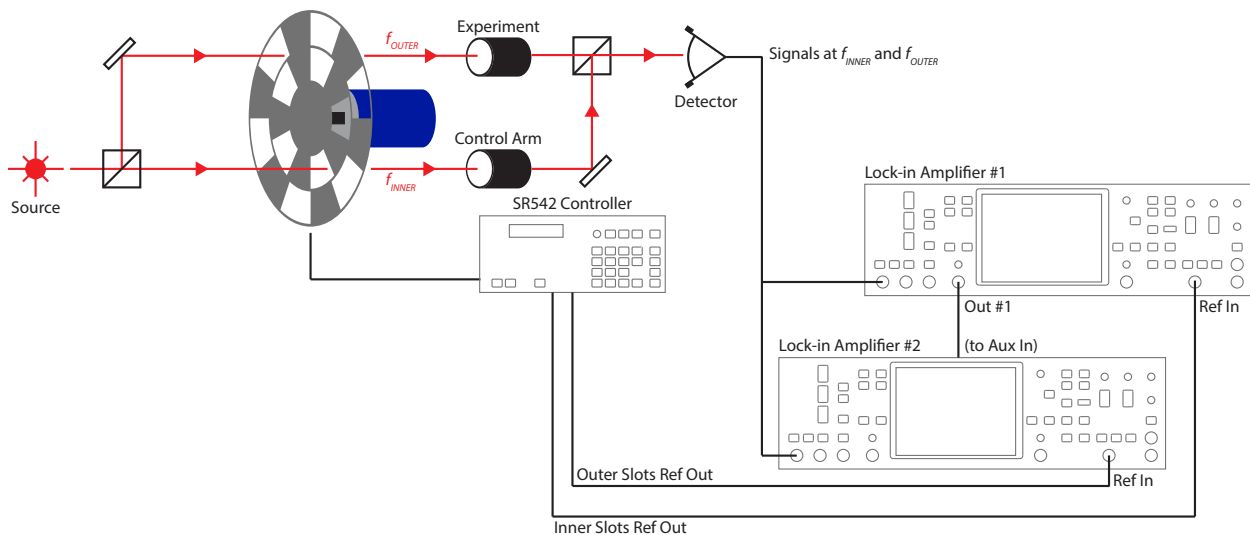
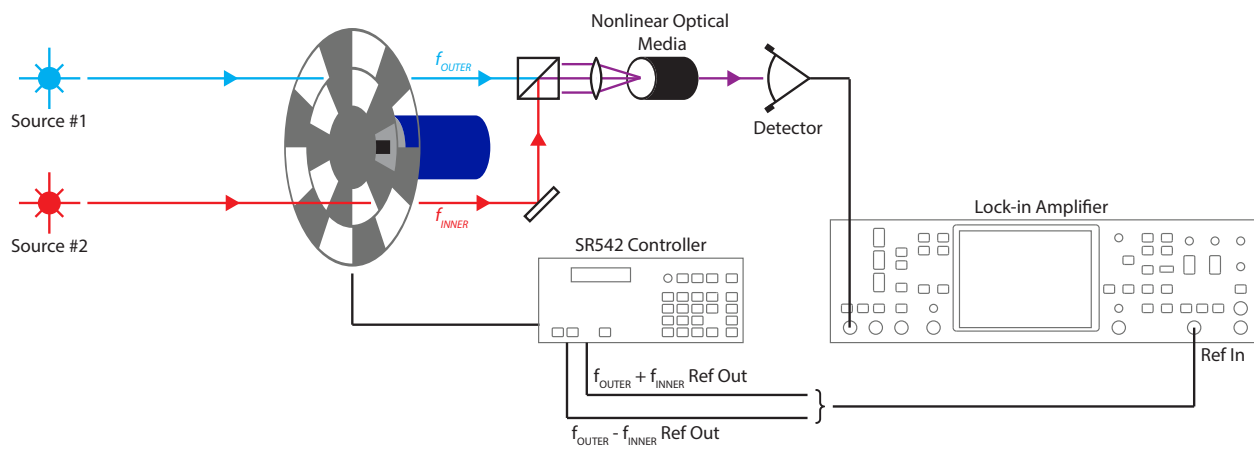

Figure 4.2: Dual Beam Experiment

### 4.3 Detection at Sum and Difference Frequencies

Certain applications require detection at the sum or difference frequency of two chopped beams. Examples include pump-probe experiments, or two-wave photomixing. In these experiments, the sample under study responds non-linearly to optical excitation. If two beams, having been chopped at different frequencies  $f_{\text{INNER}}$  and  $f_{\text{OUTER}}$ , are combined on the sample, the sample may produce a response at the sum and difference frequencies ( $f_{\text{OUTER}} + f_{\text{INNER}}$ ) and ( $f_{\text{OUTER}} - f_{\text{INNER}}$ ).

The SR542 provides synthesized reference outputs at the sum and difference frequencies, which can be provided to the reference input of a lock-in amplifier.



**Figure 4.3:** Two Beam Mixing Experiment. Source #1 and #2 need not be different wavelengths.



---

## 5 Troubleshooting

---

### 5.1 Chopper Head Cable Shield Grounding

Jumper J503 can be used to select the grounding configuration of the 10P10C chopper head cable shield at the controller RJ50 connector. With the jumper selector in position 2-3, the shield is connected to the controller's chassis ground (earth ground). With the jumper selector in position 1-2, the shield is left floating. A grounded shield (J503 in position 2-3) is the default factory configuration, as it is found to provide the best noise immunity for signals on the chopper head cable.

On the other end of the cable, at the chopper head's RJ50 connector, the cable shield is connected directly to the chopper head chassis. Therefore, when bolted to a grounded optical table, there is the possibility of a ground loop if the cable shield is grounded at both ends.



#### **WARNING**

Dangerous voltages, capable of causing injury or death, are present in this instrument. Use extreme caution whenever the instrument covers are removed. Do not remove the covers while the unit is plugged into a live outlet.

---

The procedure for adjusting J503 inside the SR542 controller is as follows. First, turn off and unplug the unit. Wait one minute after removing power to reduce the risk due to residual voltages inside the instrument. To remove the top cover, first remove the two large screws from each side of the top cover. The cover can now be removed by carefully sliding it back towards the rear of the instrument.

Locate J503 near the RJ50 connector for the chopper head cable, and select the grounded (2-3) or floating (1-2) configuration as desired.

Replace the top cover of the instrument before reconnecting to power.



---

## Index

---

- A**
- AC Line ..... 2
    - Source ..... 20, 30
  - alarm ..... 33, 55
  - ALRM ..... 55
  - aperture ..... 5, 9, 41, 69
  - Audio Settings ..... 33
- B**
- BACK ..... 55
  - baud rate ..... 4, 48
  - blade . 5, 6, 12, 13, 15, 16, 35, 41, 53, 69
    - custom ..... 9
    - dual-frequency 5, 21–23, 41, 73
    - single-frequency . . 9, 28, 41, 69
    - single-track ..... *see* blade, single-frequency
  - BNC ..... 14–16, 21, 39–41, 72
  - buffer
    - error . . . *see* error, buffer, 59
    - input ..... 48, 64, 68
    - output ..... 48, 64, 68
    - parameter ..... 68
  - button ..... 64
    - Back ..... 38
    - Backspace ..... 34
    - Cancel ..... 34
    - Control ..... 32
    - Edge ..... 31
    - Enter ..... 28
    - Left Arrow ..... 27, 32, 34
    - numeric entry 28, 29, 33, 34
    - Power ..... 27
    - Recall ..... 38
    - Rel Phase ..... 35
    - Right Arrow ..... 27, 32, 34
    - Run/Stop ..... 35
    - Save ..... 37
    - Source ..... 30
- C**
- cable
    - chopper head . . *see* chopper head, cable
  - calibration ..... 66, 69
  - CHCR ..... 61
  - CHEN ..... 61
  - CHEV ..... 61
  - CHNT ..... 61
  - chop mode ..... 22, 26, 29
    - SR860 and SR865A ..... 17
  - chopper
    - blade ..... *see* blade
    - chopper head . . 8, 12, 13, 21, 22, 41, 66, 69
      - cable . . . 2, 12, 13, 39, 66, 69
      - shield ..... 75
  - CHPT ..... 61
  - click ..... 33, 56
  - Clock
    - Shaft Reference . . 21, 31, 69
    - Source . . . 20, 28, 30, 31, 69
  - \*CLS ..... 59
  - command
    - parameter ..... 49
    - separator ..... 49
    - terminator ..... 48, 49, 57
  - configuration
    - factory default . . . 13, 35, 38, 52, 67
    - front-panel block ..... 30
    - user-defined ..... 37, 38, 54
  - Control . . . 13, 14, 32, 35, 37, 50
    - frequency ..... 21, 53
  - controller ..... 7, 12, 13
  - COPC ..... 58

- cord  
 line ..... 2, 12, 39  
 CTRL ..... 50  
 current  
 braking ..... 36, 53  
 motor drive ..... 21
- D**  
 Difference  
 frequency ..... 21, 41, 74  
 Output ..... 9, 13, 21, 41, 53  
 DISP ..... 54  
 Divisor ..... 29, 37, 51  
 DIVR ..... 51  
 duty cycle ..... *see* duty factor  
 duty factor ..... 5, 6
- E**  
 Edge ..... 31, 37, 50  
 Falling ..... 14, 31  
 Rising ..... 14, 31  
 Sine ..... 14, 31  
 EDGE ..... 50  
 encoder ..... *see* shaft encoder  
 error  
 buffer ..... 27, 34, 59, 67, 69  
 clear ..... 34  
 code ..... 34, 59, 67  
 display ..... 34  
 queue ..... *see* error, buffer  
 \*ESE ..... 60  
 \*ESR ..... 60  
 Ext Sync  
 Input ..... 14, 15, 30, 31, 40  
 Source ..... 14, 20, 30, 31
- F**  
 Factory Reset ..... 35, 52  
 firmware ..... 57  
 Frequency Monitor .. 14, 27, 28,  
 32, 33  
 Front Panel ..... 27
- G**  
 ground ..... 2, 69, 75  
 chassis ..... 2, 39  
 protective ..... 2
- I**  
 \*IDN ..... 57  
 IFRQ ..... 50  
 indicator ..... *see* LED  
 Inner  
 Control ..... 13, 23, 32  
 Frequency Monitor ..... 28  
 slots ..... 5, 9, 35  
 Slots Ref Out. 13, 16, 21, 23,  
 41  
 track ..... 5, 6, 41, 69  
 Internal Frequency  
 Setting 13, 15, 20, 29, 30, 37,  
 50  
 Source ..... 15, 20, 30  
 interrupter. *see* opto-interrupter
- J**  
 JINT ..... 50  
 Jump to Int ..... 30, 50
- K**  
 KCLK ..... 56  
 key click ..... *see* click  
 keypad ..... *see* button, numeric  
 entry  
 knob  
 clamping ..... 12  
 rotary ..... 28, 29, 32
- L**  
 LED  
 Chopper Locked . 13, 14, 32  
 Chopper Unlocked .. 13, 32  
 Edge indicator ..... 31  
 ERR ..... 27, 35, 67  
 Ext Sync ..... 30  
 Locked ..... 14, 30  
 Pending ..... 34  
 Rel ..... 35  
 Run ..... 36  
 sign ..... 27  
 Stop ..... 36  
 USB ..... 27, 48  
 VCO Input ..... 30, 40  
 LERR ..... 59  
 lock

- frequency . 13, 20, 32, 35, 65
- phase . 13, 20, 30, 32, 35, 41, 65
- lock-in . . . . . 15, 17, 39, 72–74
- M**
- memory
  - non-volatile . . 13, 33, 37, 38, 48
- MFRQ . . . . . 53
- motor . . . 12–14, 20–22, 35, 65, 69
- MOTR . . . . . 53
- MULT . . . . . 51
- Multiplier . . . . . 29, 31, 37, 51
- N**
- numeric display . . . . . 14, 27
- Numeric Entry . . . . . 34
- O**
- \*OPC . . . . . 58
- opto-interrupter . 5, 9, 12, 16, 21, 41, 69
- Outer
  - Control . . . . . 13, 15, 32
  - Frequency Monitor . . . . . 28
  - slots . . . . . 5, 25, 35
  - Slots Ref Out . 13, 15, 16, 21, 23, 41
  - track . . . . . 5, 6, 69
- overflow . . . . . 48, 64, 68
- P**
- PHAS . . . . . 50
- Phase
  - Setting 23–25, 29, 35, 37, 38, 50
- phase-locked loop . . . . . *see* PLL
- PID . . . . . 21
- PLL
  - Motor . . . . . 21
  - Source . . . . . 21, 30, 50
- power
  - cord . . . . . *see* cord, line
- power-on . . 13, 32–34, 48, 63, 64
- R**
- \*RCL . . . . . 54
- Rear Panel . . . . . 21, 39
- Recall . . . . . 37, 38
- Rel Phase . . . . . 25, 35, 37, 51
- Relative Phase . . . . . *see* Rel Phase
- REL P . . . . . 51
- \*RST . . . . . 52
- S**
- \*SAV . . . . . 54
- Save . . . . . 37
- sensor . . . . . 41
- serial
  - communication . . 39, 48, 64
  - number . . . . . 57
- Service . . . . . 2, 69
- Settings . . . . . 27, 29, 32, 33
- Shaft
  - Control . . . . . 13, 22, 32
  - Frequency Monitor . . . . . 28
  - Ref Out . . . . . 13, 21–23, 41
- shaft encoder . . 21–23, 26, 35, 69
- shroud . . . . . 12
- shutter mode . . 25, 26, 29, 35, 38
- sine . . . . . 40
- slot count . . . . . 9, 28, 53, 69
- SLOT . . . . . 53
- slots . . . . . 5, 53, 72
  - inner . . . . . *see* Inner, slots
  - outer . . . . . *see* Outer, slots
- Source . . . . . 30, 37, 50
  - Frequency Monitor . . . . . 28
  - Output . . . 13, 16, 21, 23, 40
- Specifications . . . . . 4
- SR540 . . . . . 17
- SR860 . . . . . 17
- SR865A . . . . . 17
- SRCE . . . . . 50
- \*SRE . . . . . 60
- startup . . . . 13, 31, 35, 66, 67, 69
- status
  - bit
    - Chopper Head
      - Disconnect . . . . . 66
    - Chopper Head Memory
      - Fail . . . . . 66
    - Command Error . . . . . 64

- Current Max ..... 65  
 Device-Dependent Error  
     64  
 Execution Error ..... 64  
 External Lock ..... 65  
 Frequency Lock ..... 65  
 Input Buffer Overrun . 64  
 Motor On ..... 65  
 Operation Complete .. 64  
 Phase Lock ..... 65  
 Power On ..... 64  
 Query Error ..... 64  
 Temperature Max ..... 65  
 User Request ..... 64  
 model ..... 62  
 registers  
     CHCR ..... 65  
     CHEN ..... 67  
     CHEV ..... 66  
     CHNT ..... 65  
     CHPT ..... 65  
     condition ..... 62  
     enable ..... 63  
     ESE ..... 64  
     ESR ..... 63, 64  
     event ..... 62  
     SB ..... 63, 64  
     SRE ..... 63  
     transition ..... 62  
 Status Byte ..... *see*  
     status, registers, SB  
 \*STB ..... 59  
 sticky bits ..... 62, 64  
 Sum  
     frequency ..... 21, 41, 74  
     Output ..... 9, 13, 21, 41, 53  
 survey ..... 13, 31, 35  
  
**T**  
 temperature  
     maximum operating .... 69  
 TERM ..... 57  
 token ..... 49  
 TOKN ..... 57  
 track ..... 9, 72  
     inner ..... *see* Inner, track  
     outer ..... *see* Outer, track  
 trigger ..... *see* Edge  
 TTL ..... 14, 31, 40  
  
**U**  
 units ..... 27  
 USB ..... 39, 48  
  
**V**  
 VCO FS ..... 29, 37, 40  
 VCO Input ..... 20, 40  
     Source ..... 20, 30  
 VCOS ..... 52

---

## Circuit Descriptions

---

This chapter presents a brief description of the SR542 circuit design.

<b>Circuit Discussion</b> . . . . .	<b>82</b>
Motherboard . . . . .	82
CPU . . . . .	82
Current Amplifier . . . . .	82
Signal I/O . . . . .	82
Front Panel . . . . .	83
USB-to-Serial . . . . .	84
Chopper Head Board . . . . .	84

## Circuit Discussion

The SR542 consists of 4 printed circuit boards: a motherboard, front panel display, and USB interface board in the control unit, plus a small board in the chopper head. In this chapter, page references refer to the schematics pages at the end of the manual.

### Motherboard

#### CPU

The CPU U203 coordinates all functions of the SR542, including a digital phase-locked loop for synchronizing to external signals, sensing and control of the chopper head BLDC motor, remote command processing, and front panel updates and button presses.

#### Current Amplifier

The Current Source for the BLDC motor consists of three composite Amplifier channels. These channels are labeled U, V, and W, corresponding to the conventional motor winding labels for a 3-phase BLDC motor.

In order to avoid producing high-frequency switching noise with the motor drive circuitry, the motor is driven with 3-phase sinusoidal currents, instead of pulse-width modulation, as is typical for BLDC motors. The CPU's two DAC outputs drive the channel U and V amplifiers, which are configured as Howland Current Pumps. The channel W amplifier is wired as a difference amplifier so that the common mode voltage of the motor windings is held fixed at  $\sim 9\text{ V}_{\text{DC}}$  (VMotorMid).

Each amplifier channel itself consists of a class-AB amplifier, with output stages wired in the Sziklai Configuration.

#### Signal I/O

The Signal I/O sheet consists of all the signal inputs and outputs, including Ext Sync Input, VCO Input, AC Line detection, Chopper Head signals, and 5 V CMOS drivers for the Reference Outputs.

Relay K501 selects between sinusoidal and TTL inputs for the Ext Sync signal. The TTL path is DC coupled and discriminated directly with comparator U509, with transition threshold set at +1.0 V. The polarity (rising or falling edge) is selected in firmware (U505 is simply used for 5 V-to-3.3 V level translation). The sine path is AC coupled with a 1 s time constant at C504/R526. Relay K502 selects between sinusoidal and AC Line inputs, and the selected sinusoidal signal is buffered (with gain = 100) by U504. Comparator U508 provides discrimination of the amplified signal.



The AC Line signal is picked up capacitively by a copper polygon on the printed circuit board over which the AC line and neutral wires pass. The capacitively-sensed AC signal is then low-pass filtered by R533/C527.

U507 and selects from one of the discriminated AC signals (TTL or Sine/AC Line) to be used as the frequency reference ( `ExtSync_Input` ) for the firmware-implemented phase-lock loop.

The VCO Input at J508 is divided 3-to-1, low-pass filtered ( $f_c \approx 7\text{ Hz}$ ), and buffered by U516A. U516B provides a buffered 15 mVdc reference voltage for an ADC differential measurement of `VCO_Input - VCO_Input_Ref` . This accommodates small positive off-sets of a user-supplied 0 V signal.

Line drivers U511, U512, U514, U515, U518, and U517 provide +5 V CMOS signals through  $50\ \Omega$  for each of the Reference Outputs.

Also included on the Signal I/O schematic is additional circuitry for handling the MUXing of the Chopper Head signals. U501 provides 3.3 V-to-5 V level translation for I2C signals between the CPU (3.3 V) and the Chopper Head (5 V). Buffer U503 drives the `CHOP_SWCTRL` signal to the Chopper Head in order to switch the MUX'ed lines from I2C to Shaft Encoder signals, and also protects the `CHOP_SWCTRL` pin. This is necessary since immediately after switching to Shaft Encoder signals, the `ENC_Z` signal could drive J501-6 high (5 V from the Chopper Head). The shutdown signal provided by `EN_I2C` (via U502 and U506B) sets U503 into a high impedance state.

## Front Panel

Schematics for the Front Panel PCB are organized into sheets for the Buttons, LEDs, 7-Segment displays, and Connector for interfacing to the motherboard.

All buttons other than S225 (Power Button) and S226 (Run/Stop) are diode-OR'd together to provide the interrupt signal `FP_BTN_PRESSED` . When a button press or release is detected, the CPU sets `CS_BTN` high, latching the button state into shift registers U201, U202, and U204. `CS_BTN` is cleared after the shift registers have been read out.

Dimming of the 7-Segment display DS40n is provided by Q40n/D40n ( $n = 1, 2, \dots 6$ ). When the control signal provided to the base of Q40n is low, the transistor enters saturation, and the 7-segment LED elements are driven with  $\sim \text{FP\_VCC}$  . When the control signal goes high, the transistor is cut-off, and all current to the LEDs flows through D40n, such that the LEDs are biased with `FP_VCC` - 0.6 V.

### USB-to-Serial

Remote communication via USB is provided by U902, which translates USB protocol data to asynchronous serial data (UART). U901, U903, U904, and U905 are optocouplers, which provide isolation of the SR542 power rails ( +3.3 and GND ) from noisy USB power and ground ( +5\_USB and USB\_GND ).

### Chopper Head Board

The Chopper Head Cable contains 10 conductors, and so analog switch U102 provides MUXing of lines 4, 5, and 6 between I2C communications and shaft encoder signals. Any time the Chopper Head Board is powered up, flip-flop U104 is initialized in Reset, which forces U102 to the A position. Once the I2C memory (U101) is read out by the control unit, the SWCTRL signal is pulsed, thereby clocking U104 and switching U102 to the B position, so that shaft encoder signals ENC\_A , ENC\_B , and ENC\_Z can be sent to the control unit.

U105 and U106 are the opto-interrupters for the Inner and Outer chopper blade tracks, respectively.

---

## Schematic Diagrams

---

<b>Motherboard</b> . . . . .	<b>86</b>
Motherboard Organization . . . . .	86
CPU . . . . .	87
Current Source . . . . .	88
Amplifier Channel A . . . . .	89
Signal I/O . . . . .	90
Power Regulation . . . . .	91
Remote Interfaces . . . . .	92
<b>Front Panel</b> . . . . .	<b>93</b>
Front Panel Organization . . . . .	93
Front Panel Connector . . . . .	94
Front Panel Buttons . . . . .	95
Front Panel LEDs . . . . .	96
Front Panel 7-Segment Displays . . . . .	97
<b>USB-to-Serial</b> . . . . .	<b>98</b>
<b>Chopper Head</b> . . . . .	<b>99</b>

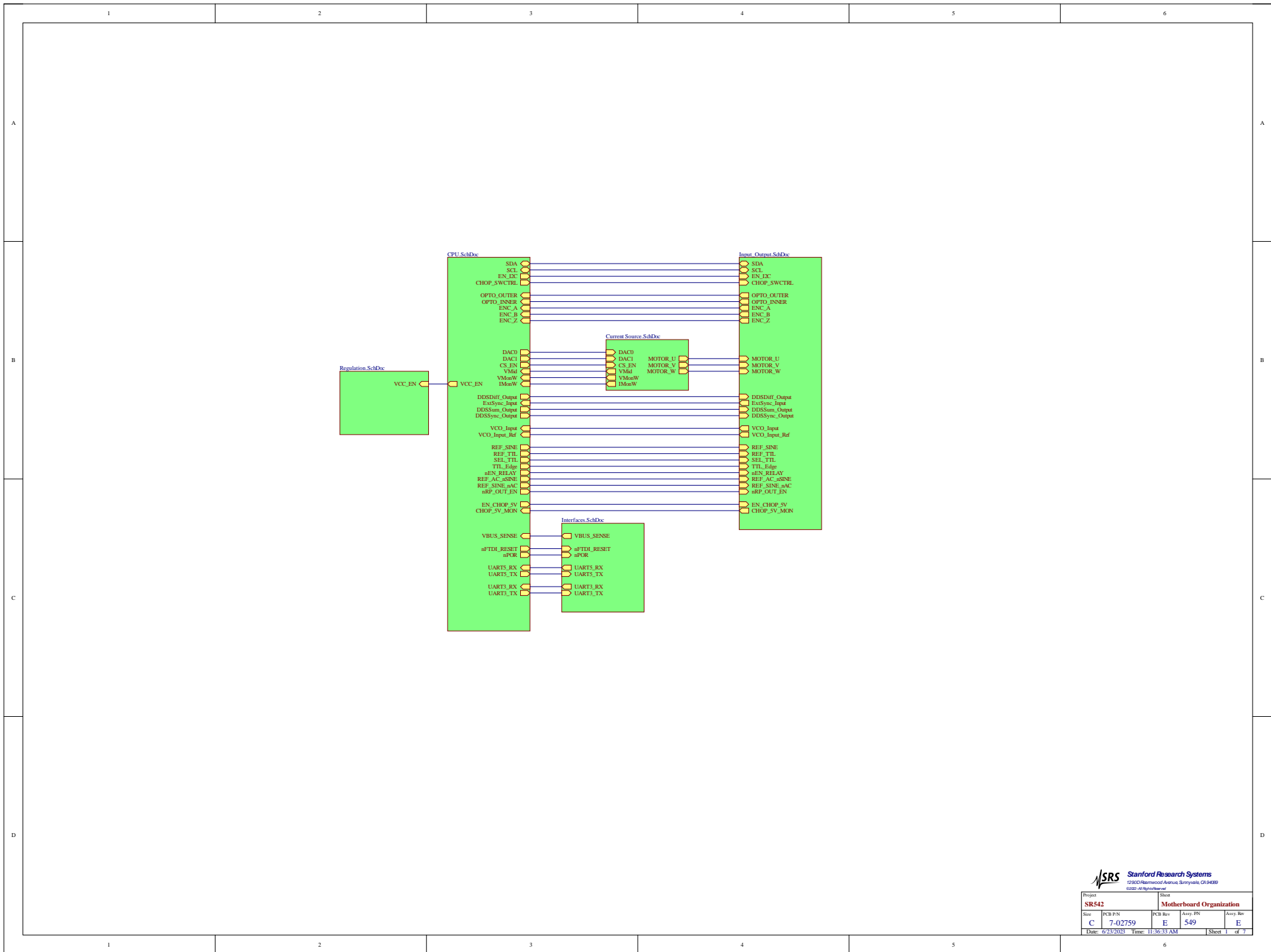



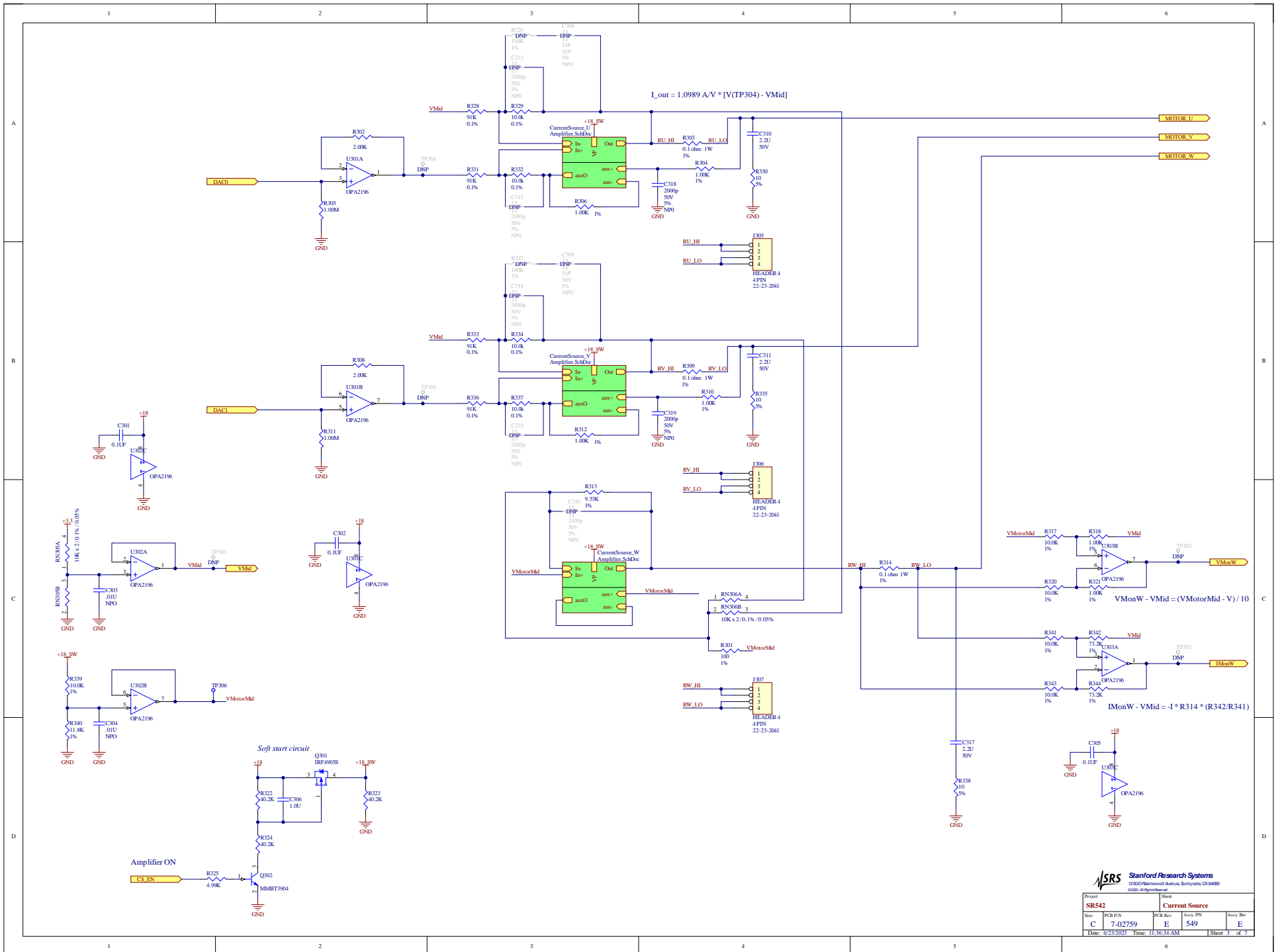

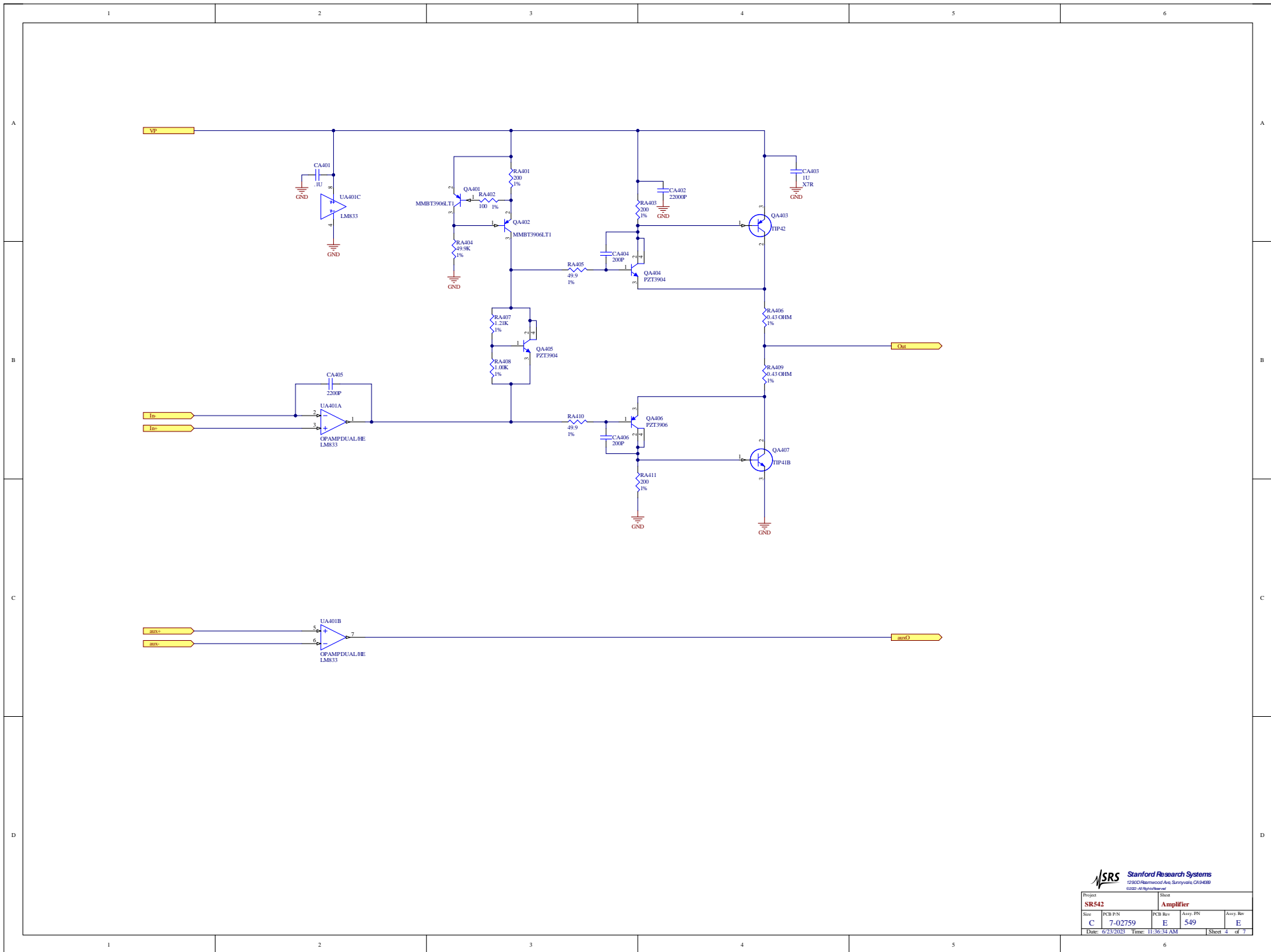

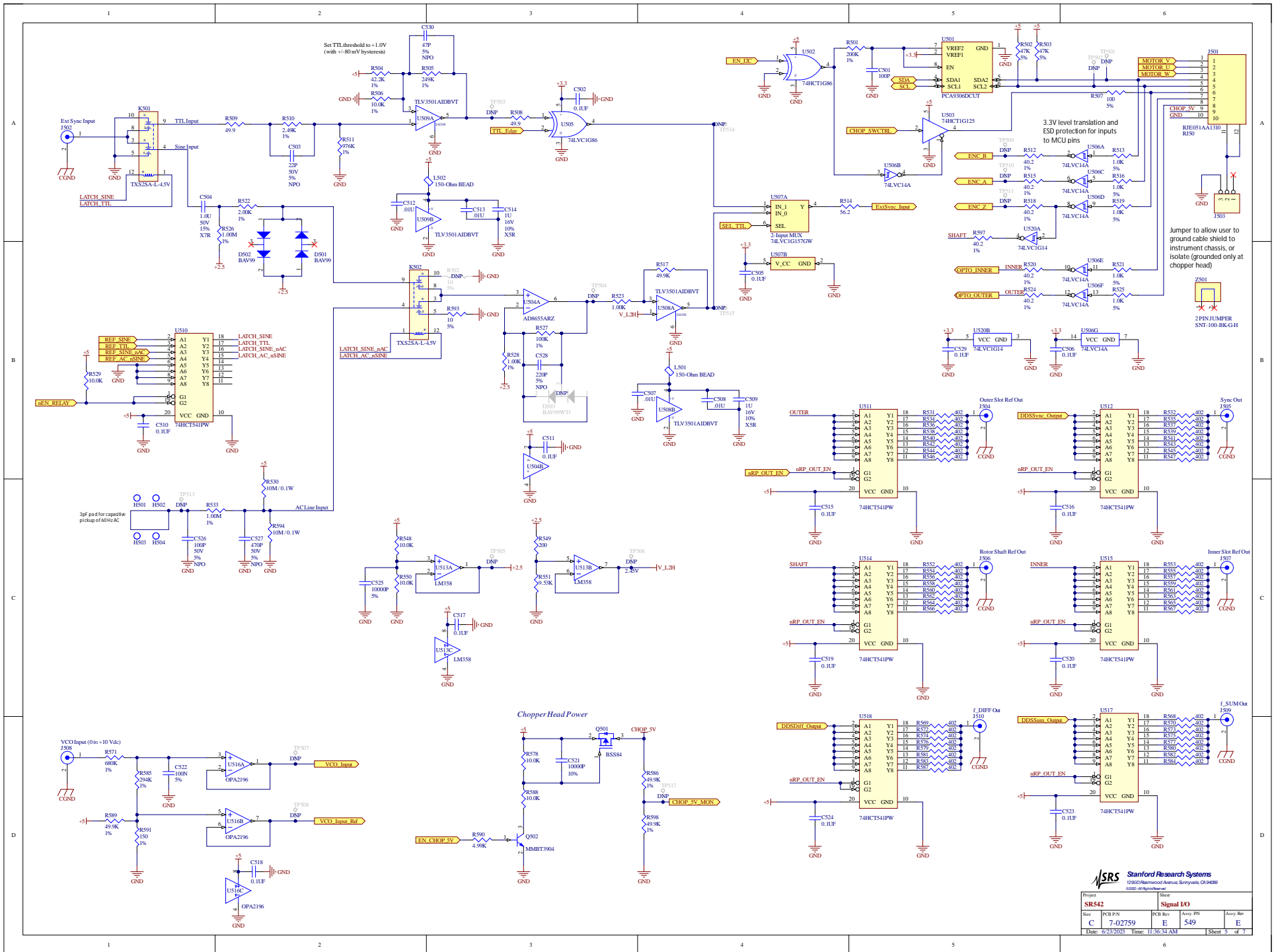



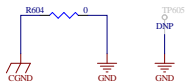
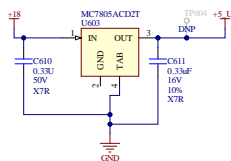
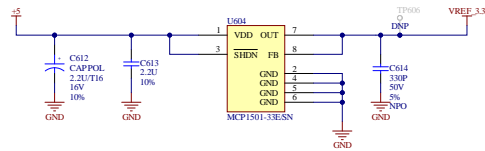
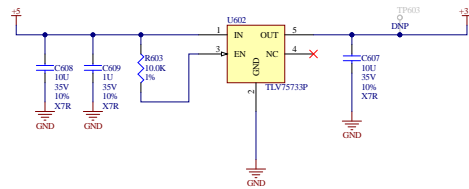
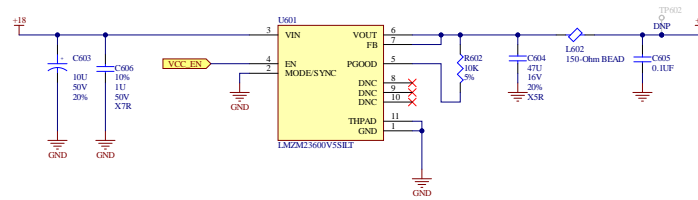
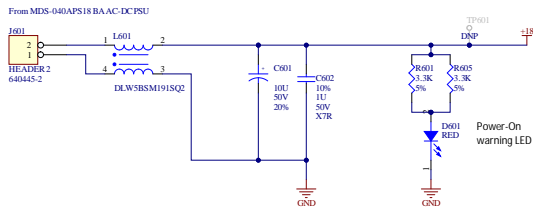



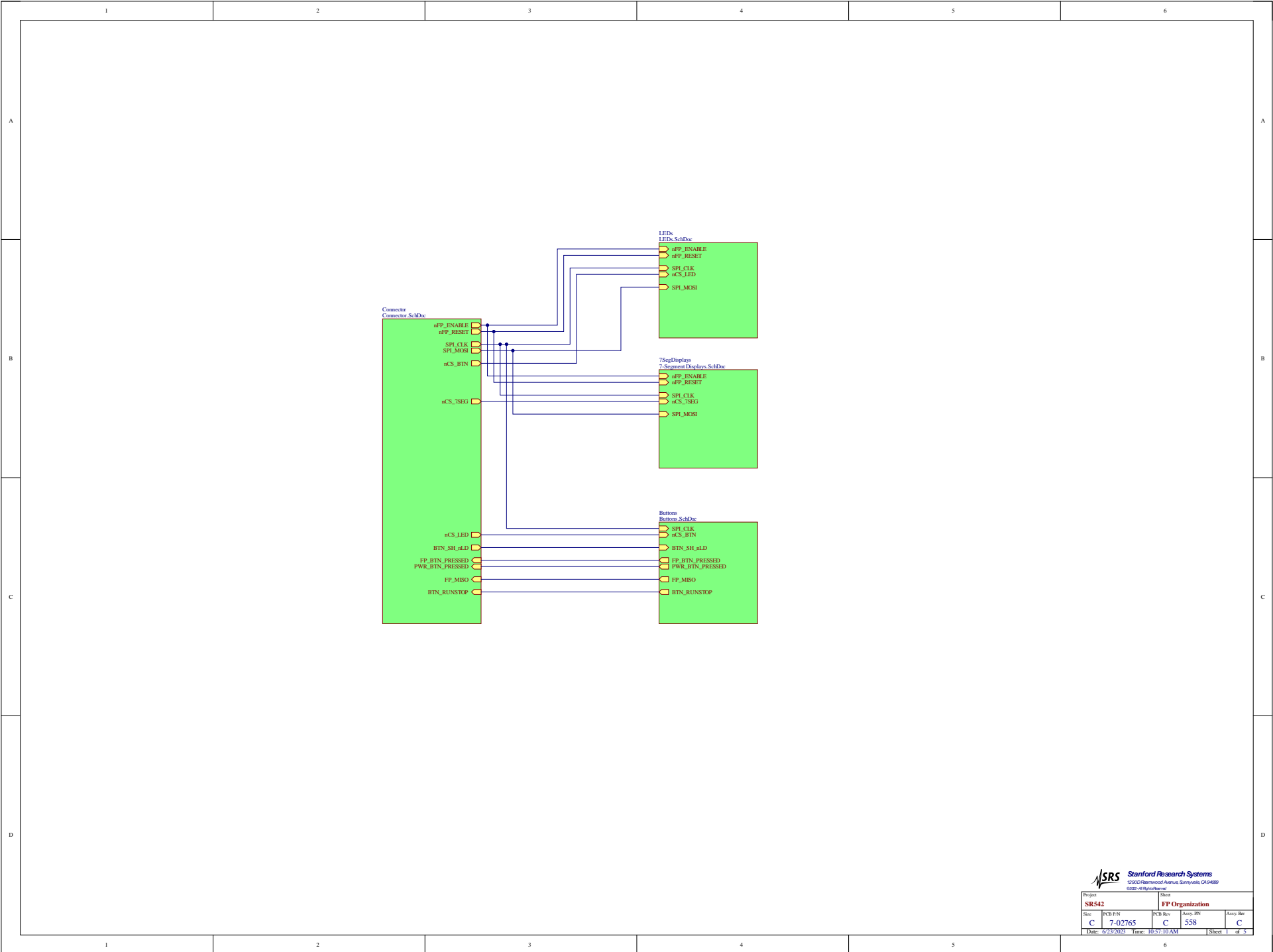

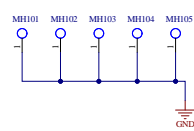
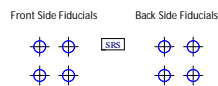
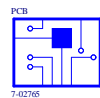
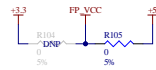
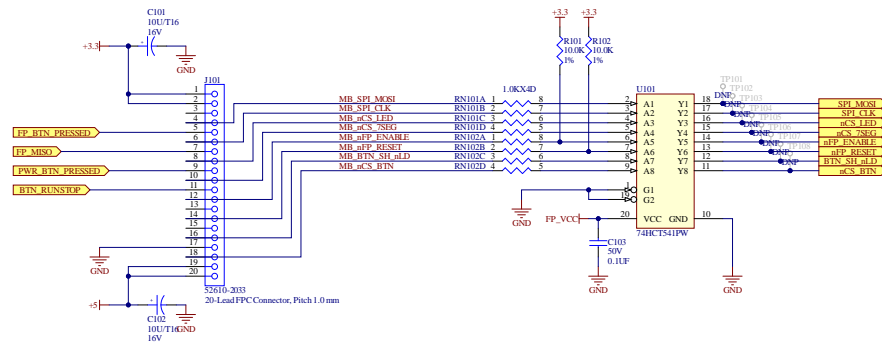

Project		Sheet	
SR542		FP Connector	
Rev:	PCB Rev:	Auto FR:	Auto BR:
C	7-02765	C	558
Date:	Time:	Sheet 2 of 5	
6/23/2025	10:57:10 AM		

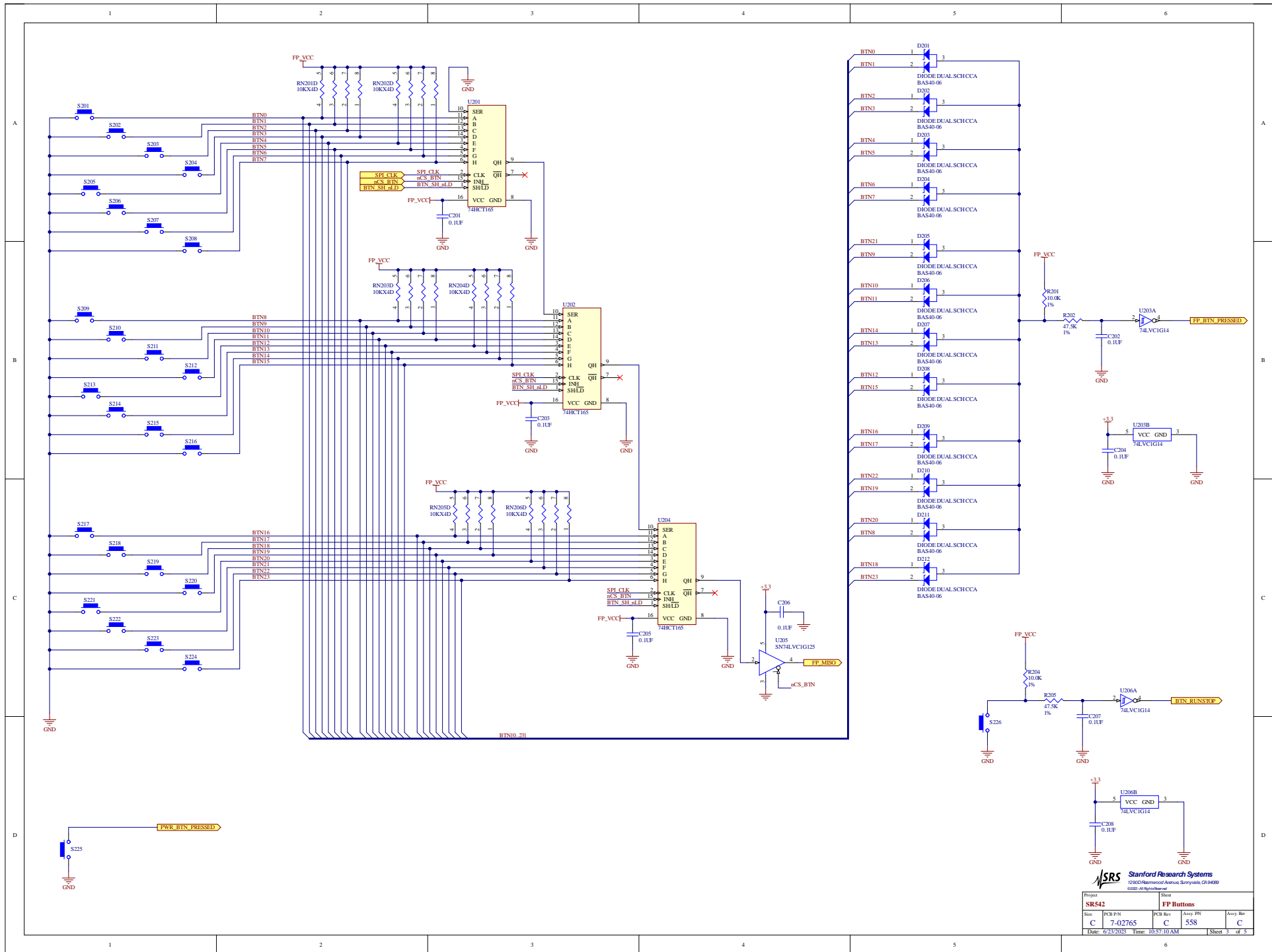

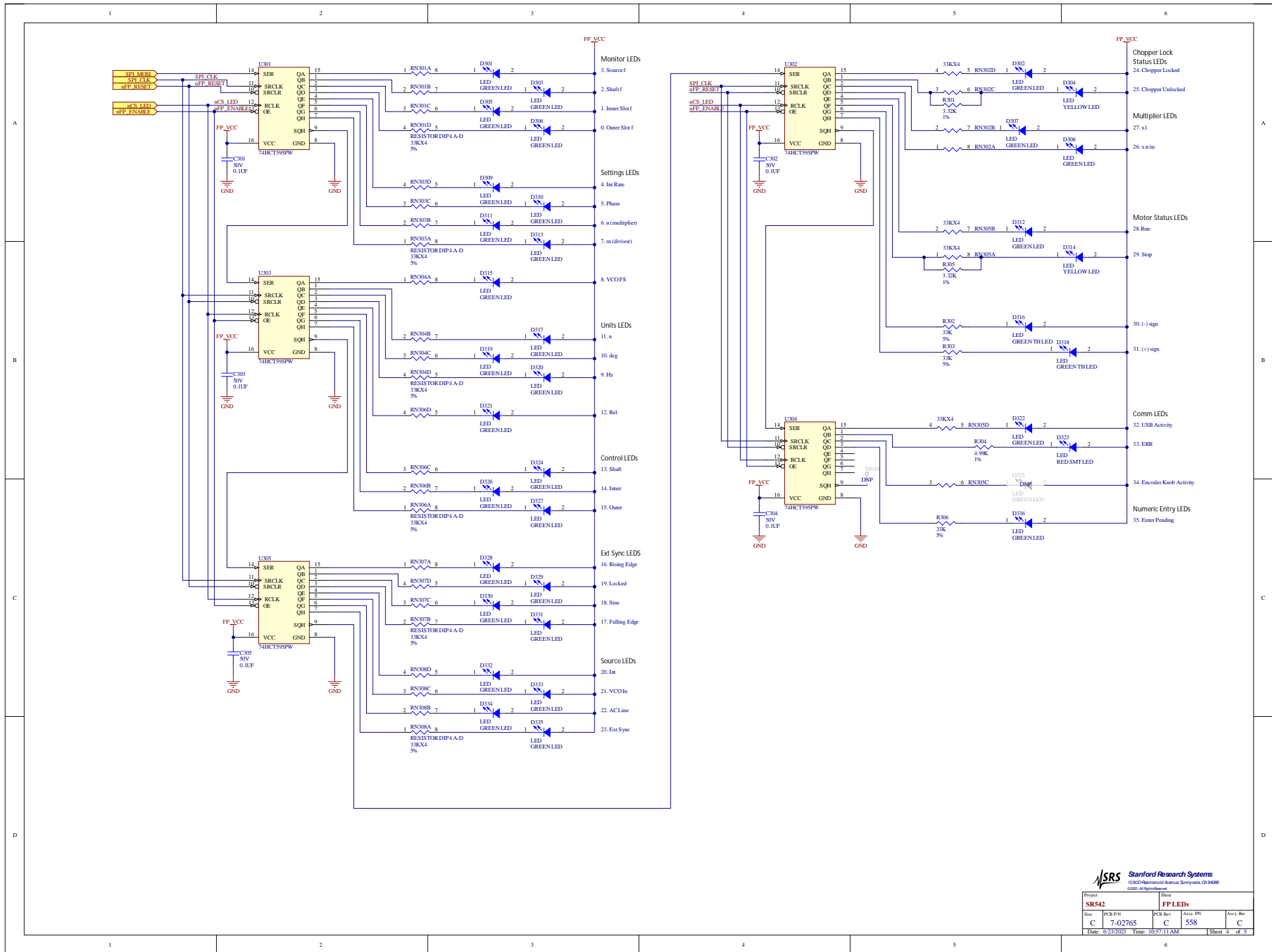

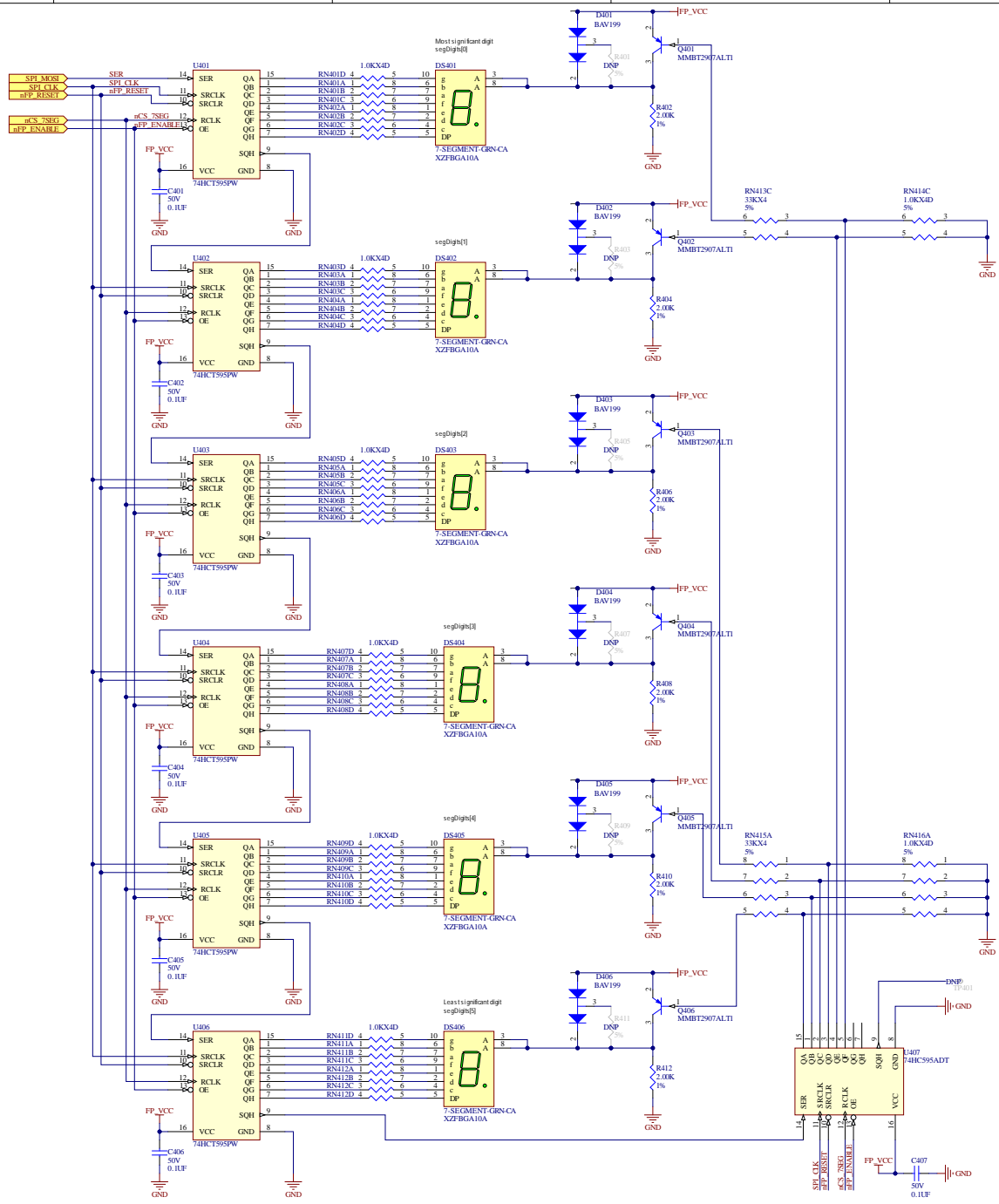

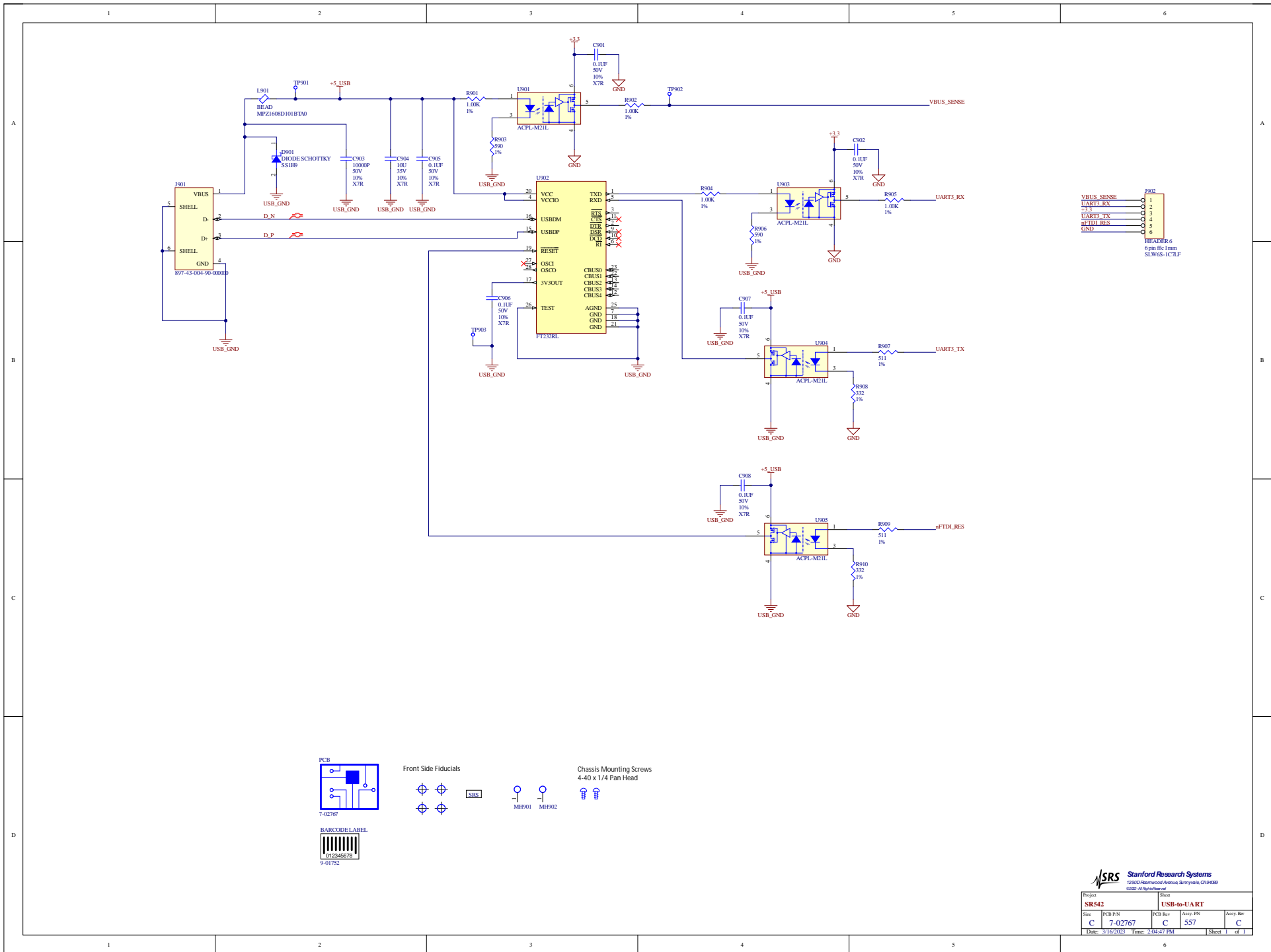

7-02767



Front Side Fiducials



SRS



Chassis Mounting Screws  
4-40 x 1/4 Pan Head



Project		Sheet	
SR542		USB-to-UART	
Date:	PCB Rev:	Auto. PRT:	Auto. No:
C 7-02767	C S57		C
Date: 3/16/2025	Time: 2:52:47 PM	Sheet 1 of 1	



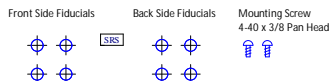
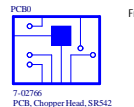
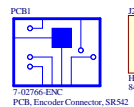
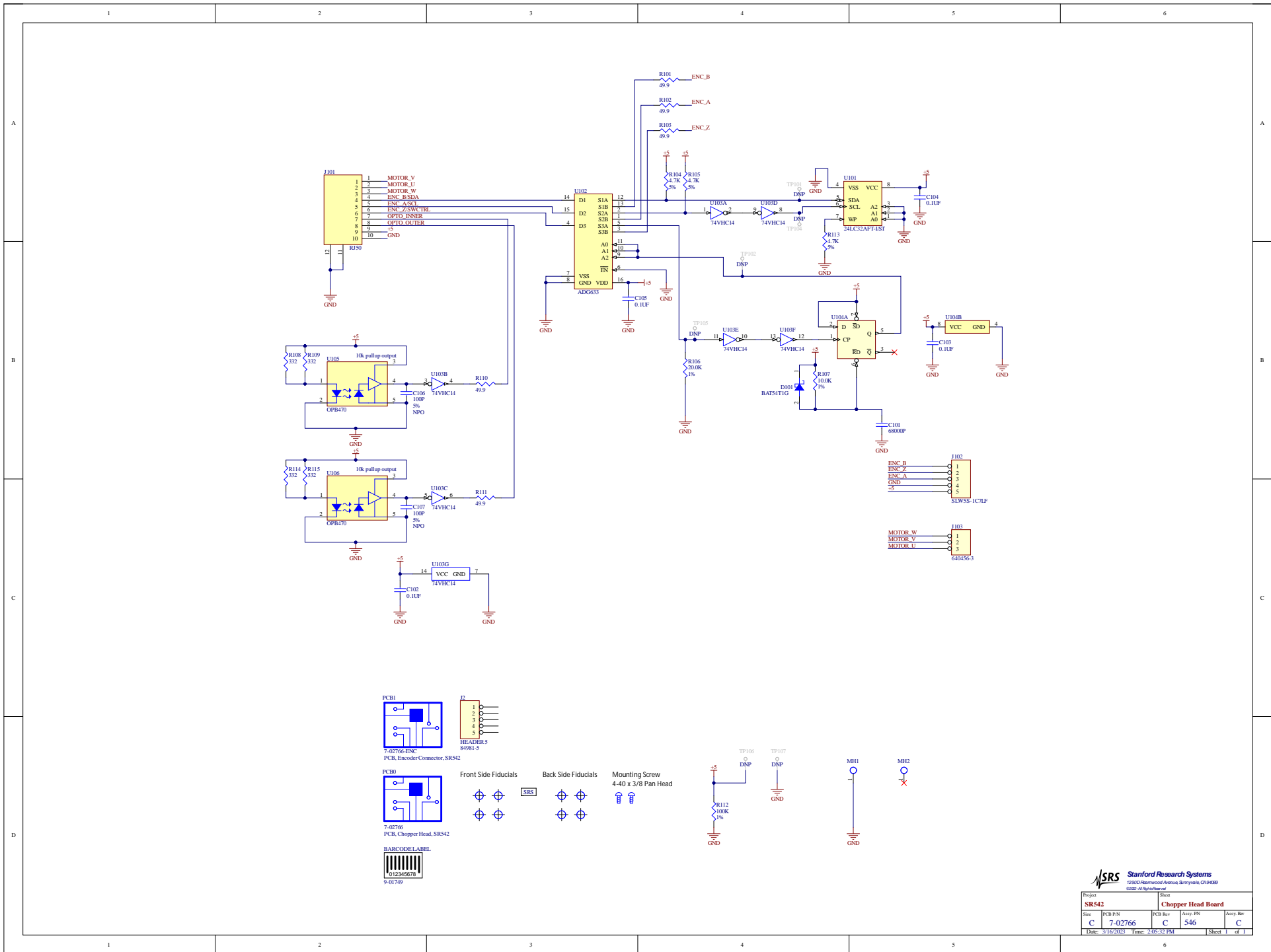

Project		Sheet	
SR542		Chopper Head Board	
Rev:	PCB 054	PCB Rev:	Assy: PTH
C	7-02766	C	546
Date:	3/16/2025	Time:	2:50:32 PM
		Sheet 1 of 1	